

Pro'sKit®

MT-7028

Network Toner & Probe Kit

CE

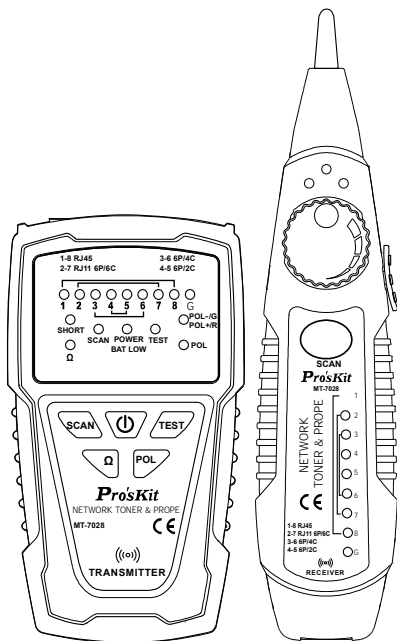

User's Manual

1st Edition,

©2014 Copyright by Prokit's Industries Co., Ltd.

Thank your for your purchase of **Pro'sKit** MT-7028 Network Toner & Probe Kit. The Toner and Probe set is used to quickly trace and identify cables or wires within a group and also check the operation of telephone lines. With proper use and care, this instrument will provide many years of reliable service.

Index

Overview.....	1
Features.....	1
Unpacking.....	3
Specifications.....	3
Safety Information.....	5
MT-7028 Transmitter.....	6
MT-7028 Receiver.....	9
Locating and Isolating Cables.....	11
Locating Individual Wire Pairs with the MT-7028 Analog Function Isolating Cables.....	12
Cable Map testing.....	14
Live telecommunication equipment and router test.....	18
Coaxial Cable & Continuity Testing.....	19
Validating Telephone Service and Polarity.....	20
NCV (Non-Contact Voltage) Testing.....	21
Battery Life and Replacement.....	22
Maintenance & Trouble shooting.....	23

OVERVIEW

The MT-7028 let you easily locate and verify the cable status and troubleshoot wiring for continuity, shorts, opens and crossover on RJ45 Lan cable Cat 5·5e·6·7 (UTP/STP)·RJ11/12 Telephone cable Cat. 3 (2/4/6 pin) & normal solid/Stranded wire by alligator clips patch cord. Ideal for all installation and maintenance fields of telecommunication, networking, datacom, Audio/Video, cable TV, and all weather cabling, etc.

FEATURES

Wire Tracing up to 3KM

- The tone and probe kit lets you easily track wire directly in connection with live telecommunication equipment and router.

Cable Mapping & status Indication up to 300M

- Fast/Slow scan functions.
- Display the result of pin to pin cable mapping.

- Display cable status and troubleshoot wiring for continuity, shorts, opens and crossover.

Non Contact Voltage detection

- Tests voltage from 90 ~ 1000V, special design to make sure the power is off before testing for circuit protection.

Polarity indication

- Identify the telephone line polarity easily.

Energy saving

- Automatically powers off after 1 hour of no operation.

ADVANCED FEATURES

- MT-7028 Transmitter generates: 1KHz audio signal with two-tone (high / low) for selection. The maximum distance of transmitter is ≥ 3 kilometers. Works with MT-7028 receiver by volume adjustment feature can precisely find the break point in the range of 10~30cm. The MT-7028 receiver contains indicated LEDs which is more accurate for testing.
- MT-7028 Transmitter works with the receiver for cable mapping by LED lights indication. The instrument can verify cable status for continuity, shorts, opens and crossover on RJ45 Lan cable and RJ11 telephone cable and test shielding/ unshielded wire. The maximum length that can be tested is 300 meters.
- MT-7028 Transmitter: LED indicators to detect the common wire resistance ($> 300\Omega$) for bad connection.
- MT-7028 Transmitter has 60V AC or DC 48V protection. Telecommunications equipment and routers can be tested in live Electrical environments without turning off the power. The transmitter can also identify the positive and negative polarity telephone lines.
- MT-7028 Transmitter : with low battery indication function and will turn off automatically after one hour non-working.
- MT-7028 Receiver : with Non Contact Voltage detection feature which can detect AC voltage from 90~1000V to avoid danger and damage by detecting the voltage in advance.
- MT-7028 Receiver : with LED lighting and earphone jack to allow the product to be used in noisy or dark environments.

MT-7028 Transmitter : with dual jacks for RJ45 Lan cable and RJ11 telephone line. The transmitter can be tested with a patch cord for RJ45 / RJ11. Coaxial cable, general cable and various wiring boards can be tested by using with alligator clip cable.

PACKING

The MT-7028 product comes with the accessories listed below. If any accessory is damaged or missing, contact the place of purchase immediately.

MT-7028 Network Tone and Probe Kit packing:

- MT-7028 Transmitter.
- MT-7028 Receiver.
- RJ45 (8 pin) to RJ45 (8 pin) patch cords.
- RJ11 (6 pin) to RJ11 (6 pin) patch cords.
- RJ11 (6 pin) to alligator clips patch cord.
- Earbud
- Storage bag.
- User's manual.

SPECIFICATIONS

MT-7028 Transmitter specifications	
Tone frequency	1kHz
Max. distance of transmission	≥ 3km
Max. distance of cable map	300m
Max. working current	≤ 65mA
Tone mode	Hi/Low two-note tone
Compatible connectors	RJ45(8 pin)/RJ11(6 pin) compatible connectors for RJ45(8 pin) 、 RJ11/12(6P/2C/4C/6C) cable map and RJ45 tone 、 RJ-11(6 pin) connectors for RJ11/12(6P/2C/4C/6C) tone
Cable types tested	RJ45 Lan cable Cat 5 、 5e 、 6 、 7 (UTP/STP) 、 RJ11/12 Telephone cable Cat 3 (6P/2C/4C/6C)
Function selection	5 Push button switch (POWER 、 SCAN 、 TEST 、 Ω 、 POL)
Continuity test	1 LED (≤ 300Ω), Coaxial cable & normal solid/Stranded wire by alligator clips patch cord.
Max. signal voltage	8Vp-p

Cable map indication	8 LEDs, Fast/Slow dual speed
Shielded indication	1 LED
Phone line polarity indication	1 Dual color LED
Live telecommunication equipment test and router test	Yes
Voltage protection	AC 60V or DC 48V
Auto power off	1 hour
Low battery display	6.5V (Power LED flashes)
Battery type	DC 9.0V (NEDA 1604/ 6F22 DC9V ×1pcs)
Dimension (L×W×D)	138×80×35 mm
Weight	140g
MT-7028 Receiver specifications	
Frequency	1kHz
The Max. working current	≤50mA
Compatible connectors	RJ45(8 pin)/RJ11(6 pin)
Function selection	3 Position mode switch (NCV · OFF · LED)
Earphone jack	1
Signal status indication	1 LED & Buzzer
Cable map indication	8 LEDs
Shielded indication	1 LED
NCV indication	1 LED (AC90~1000V · ≥50mm · ≤100mm)
LED illumination	1 LED
Battery type	DC 9.0V (NEDA 1604/ 6F22 DC9V ×1pcs)
Dimension (L×W×D)	198×45×33 mm
Weight	80g

Transmitter drop test(Shock and Vibration) : 1 Meter

Operating temperature : 0 ~ 50°C (32 ~ 122°F)

Storage temperature : -10 ~ 60°C (14 ~ 140°F)

Operating humidity : 20% - 75% RH

Storage humidity : 10% - 90% RH





Operating altitude : 3,000 meters

Storage altitude : 10,000 meters

SAFETY INFORMATION

Table 1 describes the international electrical symbols used on the tester and in this manual.

Table 1. International Electrical Symbols

	Warning : Risk of personal injury. See explanations in the manual. Caution : Risk of damage or destruction to equipment or software. See explanations in the manual.
	Warning : Risk of electric shock.
	Please keep an eye on the status or function of the equipment while operating.
	This equipment not for connection to public communications networks, such as active telephone systems.



Warning

- Never use the Transmitter or Receiver on circuits of more than AC 60V or DC 48V.
- Never use the Transmitter, Receiver, or test leads if they are damaged. Inspect the cases and test leads for damage before use.
- Disconnect unused test leads and connectors from the Transmitter when testing telephone circuits.
- Never open the case except to change the battery or the fuse; no user-serviceable parts are inside.
- Turn off the Transmitter or Receiver and disconnect all test leads before replacing the battery.
- Use only a 9V battery, properly installed in the case, to operate the Transmitter and Receiver.
- If this equipment is used in a manner not specified by the manufacturer, the protection provided by the equipment may be impaired.



Caution

- Avoid touching the Receiver tip to patch panel connections and using the tip to dig into cable bundles. Doing so regularly may damage the Receiver tip over time.
- To avoid unreliable test results, replace the battery as soon as the low battery indication appears.

INTRODUCTION

MT-7028 Transmitter :

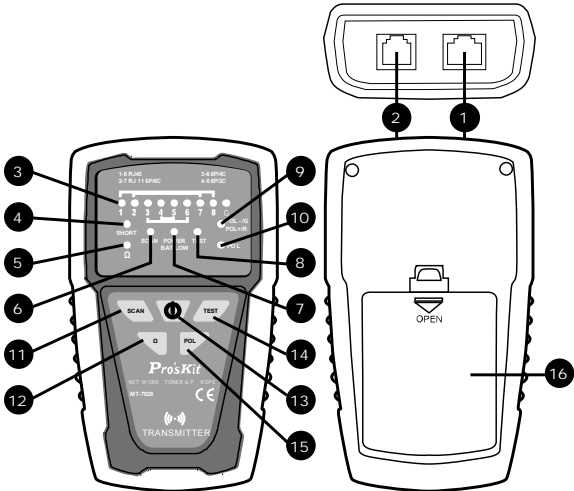

Figure 1 MT-7028 Transmitter Diagram

- 1. RJ45(8 pin)/RJ11(6/4/2 pin) Compatible connectors :**
Used for RJ45/ RJ11 cable mapping and RJ45 cable tracing. When used for RJ45/ RJ cable mapping, please connect the cable to RJ45(8 pin)/RJ11(6/4/2 pin) Compatible connectors of MT-7028 receiver to start the function.







Caution! Do not plug in any live cable to the **RJ45(8 pin)/RJ11(6/4/2 pin) Compatible connectors**. RJ11 cable tracing can not be operated by this connector.

2. **RJ11(6 pin) Connectors** : Used for RJ11 (6P/6C/4C/2C) cable tracing.



Caution! Do not plug in any live cable over AC 60V/ DC 48V to the transmitter.

3. 「**1~8·G**」 **Cable map & Shielded indication** : Work with MT-7028 receiver for RJ45/ RJ11 cable mapping indicated by 8 LED and for shielded/unshielded indication.
4. 「**SHORT**」 **Continuity test indication** : When the indication lights up means the resistance of cable is less than 300Ω or the cable is short. If the indication doesn't light up, it means the resistance of the cable is over 300Ω or the cable is open.
5. 「**Ω**」 **Continuity function indicator** : Push “” button to start continuity/ short features when the indication lights up.
6. 「**SCAN**」 **Locating and Isolating Cables function indicator** : Push “” button for cable tracing feature. When the indication LED flickers slowly, it means low-tone tracing function is working. Push “scan” button again to switch to high-tone tracing function and the indication LED will flicker faster.
7. 「**POWER/BAT LOW**」 **Power ON/OFF & Battery low indicator** : Push “” button to turn on the transmitter. When the indication lights up, the product is working. Select different functions by pushing other buttons. When the battery voltage is less than 6.5V, the indication LED will flicker, please replace a new battery for the product.
8. 「**TEST**」 **Cable map & Shielded function indicator** : Pushing “” for cable mapping and shielded function indication. When the LED flickers slowly, the low speed scan is working. Push the TEST button again, the fast speed scan will be operated.
9. 「**POL -/G · POL +/R**」 **Phone line polarity indication** : This is a dual color LED. When the red alligator clip connects positive polarity and black alligator clip connects negative polarity, the LED will be in RED color. If the

alligator clips connect in opposite way, the LED will be in GREEN color. If the LED did not light up, it means there is no electrical on the cable.

10. 「POL」 **Phone line polarity function indicator** : Push “POL” button to operate the feature of phone line polarity checking.
11. 「SCAN」 **Isolating Cables function push button** : Push “SCAN” button for cable tracing feature. When the indication LED flickers slowly, it means low-tone tracing function is working. Push “scan” button again to switch to high-tone tracing function and the indication LED will flicker faster.
12. 「Ω」 **Continuity function push button** : Push “Ω” button to start continuity/ short features when the LED lights up.
13. 「⏻」 **Power ON/OFF push button** : Push “⏻” button to turn on the transmitter. Push the button again to turn off the transmitter and the “POWER/ BAT LOW” indicator will be off as well.
14. 「TEST」 **Cable map & Shielded function push button** : Push “TEST” for cable mapping and shielded function indication. When the light flickers slowly, the low speed scan is working. Push the TEST button again, the fast speed scan will be operated.
15. 「POL」 **Phone line polarity function push button** : Push “POL” button to operate phone line polarity function.
16. Battery cover

MT-7028 Receiver :

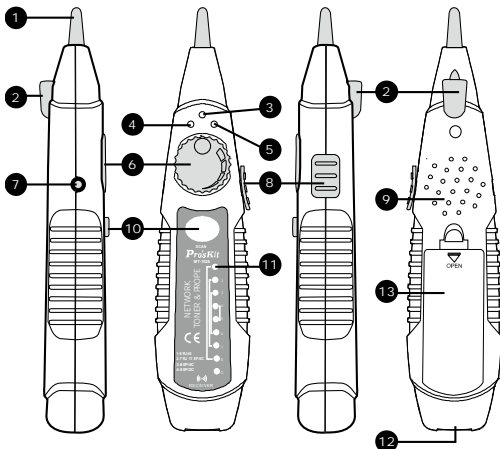

Figure 2 MT-7028 Receiver Diagram

1. **Probe** : Used for cable tracing and NCV detection.
2. **LED illumination** : Used for dark working environment.
3. **Power ON/OFF indicator** : The indicator will be lighted up when the switch at LED or NCV position and the receiver started the functions. When the switch at OFF position, the indicator will be light up when pushing "SCAN" button for cable tracing.
4. **NCV indicator** : When the probe closes to the tested object to detect the voltage, the indicator will light up if the object carried AC90~1000V. If the indicator did not light up, there is no voltage detected from the object or the AC voltage is less than 90V.
5. **Signal status indicator** : When doing cable mapping by probe, if the indication LEDs (1~8) more light up, the signal is stronger.
6. **Volume control** : By adjusting the volume from high to low to adjust the sensitivity of probe. Move the position of receiver from 30 cm to 10cm to find out the cable you are tracing.

7. **Earphone jack Φ 3.5mm** : Earphone can be used when the working area is noisy.
8. **Function selection : 3 Position mode switch (NCV 、 OFF 、 LED)**
9. **Speaker** : When “SCAN” feature is working, if the speaker is louder, the signal is stronger.
10. 「SCAN」 **Locating and Isolating Cables function push button** : When pushing the “SCAN” button, the feature starts and the battery indicator will be light on.
11. 「1~8、G」 **Cable map & Shielded indication** : Work with MT-7028 transmitter for RJ45/ RJ11 cable mapping indicated by 8 LED and for shielded/ unshielded indication.
12. **RJ45(8 pin)/RJ11(6/4/2 pin) Compatible connectors** : Used for RJ45/ RJ11 cable mapping. When used for RJ45/ RJ11 cable mapping, please connect the cable to RJ45(8 pin)/RJ11(6/4/2 pin) Compatible connectors of MT-7028 transmitter to start the function.



Caution!

Do not plug in any live cable to the RJ45(8 pin)/RJ11(6/4/2 pin) Compatible connectors.

13. Battery cover.

OPERATION

Locating and Isolating Cables :

Using MT-7028 Networking Tone & Probe kit to locate and insolate cables using the 1KHz analog, also trace twisted wires (UTP, STP, Cat 5e, Cat 6) and telephone line (Cat 3). Use with a patch cord for RJ45 / RJ11. Coaxial cable, general cable and various wiring boards can be tested by using with alligator clip cable.



Warning

- It is not intended to be used on live wires with a DC power source (e.g., live telephone lines), nor will it work on wire pairs that are carrying AC signals.
- Use RJ45(8 pin)/RJ11(6/4/2 pin) compatible connector for RJ45 cable tracing. Use RJ11(6 pin) connector for RJ11(6P/6C/4C/2C) cable tracing. Use RJ11 (6 pin) connector and work with alligator clips for coaxial cable, general cable and various wiring boards.







Caution

- To locate and isolate cables using the 1KHz analog toning mode, please avoid interference sources like electronic devices with adapter, induction coil, and motors nearby. White noise from MT-7028 Receiver is normal when your Transmitter is near any of the interference. If you cannot locate the signal on 2-conductor cables, the cable may be shorted. Please keep away from the interference sources or turn off the electronic devices.
- The position on the MT-7028 Transmitter and Receiver lets you use the Receiver to trace using an analog 1KHz tone. When using the Receiver to isolate the tone source in the cable bundle or at the patch panel, the signal might be interfered with or decreased and the signal will not pass through metal tubes.
- It is not necessary to touch the Receiver's tip to the cabling or patch panel when searching for the Transmitter's signal.
- Make sure the black alligator clip of the Transmitter is connected to the ground before use.

MT-7028 Transmitter provides two 1 KHz analog toning modes, Hi/Low two-note tone, for location and isolating cables. Both toning signals are available at all connectors on the Transmitter.

Locating Individual Wire Pairs with the MT-7028 Analog Function

To locate cables, do the following steps (Figure 3) :

1. Connect the black alligator clip of the Transmitter to the ground, and then connect the red clip to a jack or punch-down block as shown in Figure 3.
2. As the Figure 3 shown, when push , the indicator of "POWER/ BAT LOW" will light up and turn on the power. Push  button for cable tracing. When the RED indicator flickered, the low-tone cable tracing is working. Push  button again to feature the high-tone cable tracing, the RED indicator will flicker faster. Push  button again, the RED indicator will be stopped and standby for next operation.
3. AS the figure 3 shown, push  on receiver to operate cable tracing function. The tracing sound will be output from speaker. When put on earphone, there will be no sound from speaker, but from the earphone.
4. Use the Receiver to find the general location of the tone at a cable rack, patch panel, or behind a wall. In locating mode, the Receiver's LEDs light up in red from 1 to 8, then wrap back and light up from 1 to 8 again as the signal strength increases.
5. Adjust the Volume Control on the Receiver to locate the wire pairs from 10cm to 30cm.

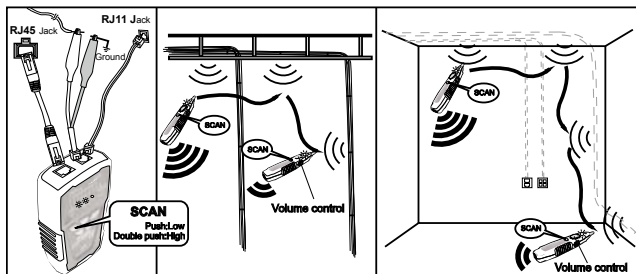

Figure 3 Locating cables

Isolating Cables:

To isolate the tone source in the cable bundle or at the patch panel, do the steps as described in the previous section of "Locating Cables".

1. Strip the cable's shield to a length of between 30 to 45 centimeters and divide the wires into two parts. Do the wire separation to isolate the cables to verify the signal of each part. If the beeper gets louder and LED lights up, you have located the position you are looking for.
2. Adjust the volume control from high to low to enable looking for a more difficult to identify wire. Narrowing the length from 30 to 10 centimeters will help to more accurately identify the wire pairs.
3. Repeat the steps of 6 and 7 to isolate the bundled cables.



Caution

- If you cannot locate the MT-7028 signal on 2-conductor cables, the cable may be shorted or opened. Use the Continuity Test (Fig. 8) to check for shorts or opens on coax and non-terminated cables.

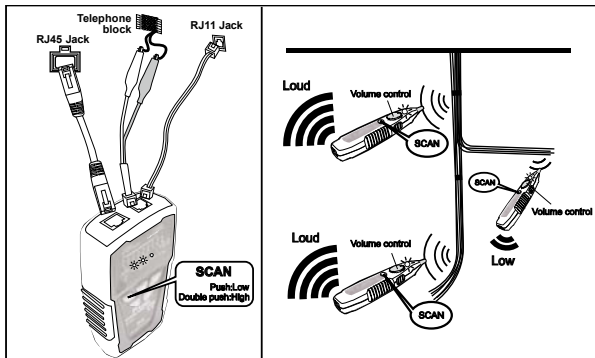





Figure 4 Isolating Cable

Cable Map Testing :



Caution

- When use the product for RJ45 or RJ11 cable mapping, please only plug in the cable to RJ45/RJ11 compatible connector on transmitter. Do not use RJ11 (6pin) connector.
 - You can use the MT-7028 Transmitter or Receiver to validate the cable map on RJ45/RJ11 by RJ45/RJ11 compatible connector on transmitter. The cable map function finds the most common wiring faults on twisted pair cabling: shorts, opens, and crossed pairs.
1. Connect the MT-7028 Transmitter or Receiver to RJ45/ RJ11 jacks.
 2. Push “”, the indicator of “POWER/ BAT LOW” will light up and turn on the power. Push “” on MT-7028 transmitter for cable mapping and shielded function indication. When the green LED indicator flickers slowly, the low speed scan is working. Push the “” button again, the green LED indicator flickers faster and the fast speed scan will be operated. Push the “” button again, the product will be standby for next operation.



Caution

- Each LED that corresponding to an active pin flashes briefly, and then should light for about 1 second. For fast scan cable mapping, the light will be flicker about 0.5 second, from 1 to 8, G. If the cable is open, the LED indicator will not light up.
- Before cable map testing, repeat the procedures of “Locating Cables” on page 7 to identify the correct connector or wires on the other end of the cable if necessary.

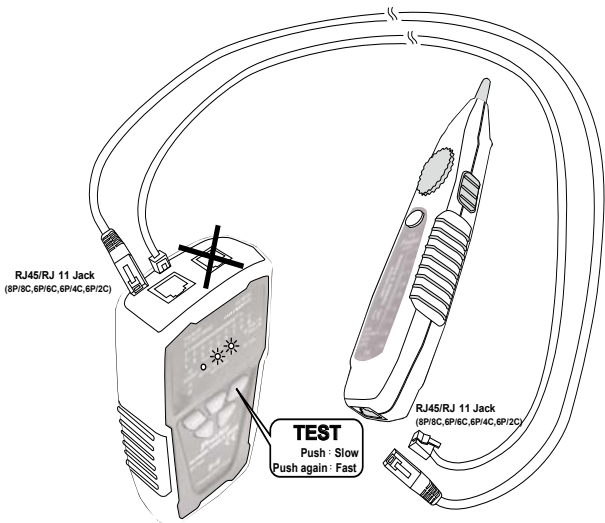
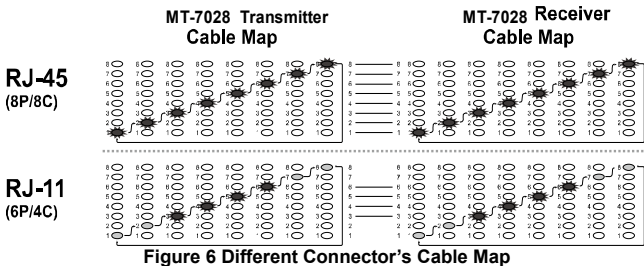

Figure 5 Validating Cable Maps

3. Different connectors generate different LED and sound indications as shown in Figure 6.
 - **RJ45(8P/8C) LED indication** : MT-7028 Transmitter (from 1-8 seconds in sequence) is synchronized with the MT-7028 Receiver cable map.
 - ▲ **RJ11(6P/6C, 6P/4C, 6P/2C) LED indication** : MT-7028 Transmitter cable map, 6P/6C each second from 2 to 7 in sequence, 6P/4C each second from 3 to 6 in sequence, 6P/2C each second from 4 to 5 in sequence is synchronized with the MT-7028 Receiver cable map. If it encounters an empty line, the indication will cease.



4. You can use the MT-7028 Transmitter and Receiver to validate the cable map on RJ11 and RJ45 connectors. The cable map function finds the most common wiring status on twisted pair cabling: good, shorts, opens, and crossed pairs as shown in Figure 7.
 - **Good wiring:** Each LED that corresponding to an active pin flashes briefly and in a stairway order.
 - **Shorts:** If two LEDs turn on for 1 second at the same time, those two pins are shorted together. If more than 2 wires are shorted together, the LEDs for the shorted pins indicate opens.
 - **Opens:** If an LED flashes briefly, then no LEDs turn on, that pin is open.
 - **Crossed pairs:** If one LED flashes briefly, then another LED lights for one second, the wire for the first LED is crossed pairs to the pin for the second LED.

5. Each LED that corresponds to an active pin flashes briefly, it should light for about 1 second. The brief flash shows which LED is next in the sequence.

**MT-7028 Transmitter
Cable Map**

**MT-7028 Receiver
Cable Map**

**1~8
Good**



**3,4
Shorts**



**3
Opens**



**3,4
Crossed
Pairs**

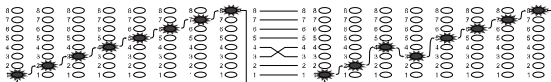





Figure 7 good wiring, shorts, opens, crossed pairs

Live telecommunication equipment and router test:

 **Caution !** The feature can only be used for testing cable continuity and opens, cannot be used for cross over and short.

1. According to Figure 8, connect MT-7028 transmitter and working router by RJ45(8P/8C).
2. Push  button to turn on the power, "POWER/ BAT LOW" indicator will light up. Push  button on transmitter to feature cable map function. When the TEST indication green LED flickers slowly, the slow cable mapping is working and the red cable map LED starts scanning. Push  button again, the TEST indication green LED twinkled fast, the fast cable mapping is working and the cable map LED starts scanning. Push the button again, the TEST green LED light will be off and the product will be standby for next operation.
3. When the "1~8, G" LED indicator on MT-7028 transmitter lighted one by one, the cable (1~8, G) is good. If any of LED indicator is not lighted, the cable is damaged.

RJ45 Jack

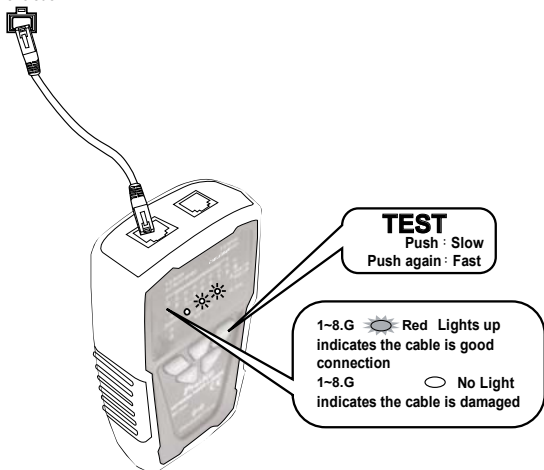





Figure 8 Cable testing on working line

Coaxial Cable & Continuity Testing:



DANGER: Before testing, please be sure the power of receiver is OFF.

To validate cable shield during cable map tests, do the following as shown in Figure 9:

1. Connect the Transmitter to the circuit as shown in Figure 8. Connect the test leads to the coaxial cable to be tested.
2. Push “” button to turn on the power, “POWER/ BAT LOW” indicator will light up. Push “” button on transmitter for short/ open function, the green LED indicator lights up and the short/ open testing is working. Push “” again, the green LED lights off and the product is standby for next operation.
3. When “SHORT” red LED indicator lights up, the cable is connected. (the resistance of cable is less than 300Ω). If the indicator is off, the cable is short or resistance of the cable is over 300Ω .

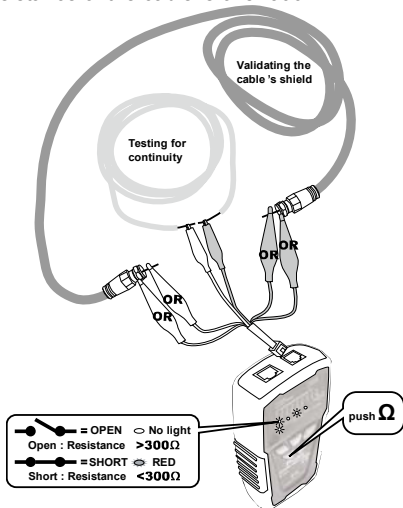



Figure 9 Coaxial Cable & Continuity Test

Validating Telephone Service and Polarity :

Please follow the following steps to check the polarity of telephone lines:

1. Connect the Transmitter to the circuit as shown in Figure 9. Connect the test leads to the telephone punch-down blocks, RJ11, and RJ45 jacks.
2. Push  button to turn on the power, "POWER/ BAT LOW" indicator will light up. Then push  to operate the polarity indication feature and the LED indicator will light up. Push the button again to get the product back to standby status.
3. 「POL-/G · POL+/R」 LED indicator is dual color (Red/ Green). The LED indicator of the Transmitter indicates the status as below:
 - **Red light** : Red test lead at positive (+) polarity ; Black test lead at negative (-) polarity.
 - **Green light** : Red test lead at negative (-) polarity ; Black test lead at positive (+) polarity.
 - **No Light** : Non service or line fault.

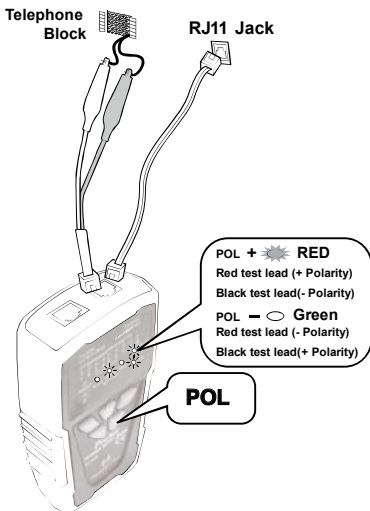

Figure 10 Validating Telephone Service and Polarity

NCV (Non-Contact Voltage) Testing :



Caution

- The feature can be used before locating, isolating, cable mapping to identify if the tested cable is with AC voltage. It can not only help to ensure the safety of user and avoid possible electric shock or personal injury, but also protect the product from being damaged by AC power.
1. Per Figure 11, turn the switch to “NCV”, the function is started when the power indication is on.
 2. When doing the NCV testing, place the probe of MT-7028 receiver to the tested cable, the NCV indicator twinkled fast and the buzzer sounded it means the tested objective has AC 90~1000V. If the indicator did not come on and no buzzer sounded, it means the tested objective has AC power less than 90V or there is no AC power on it.

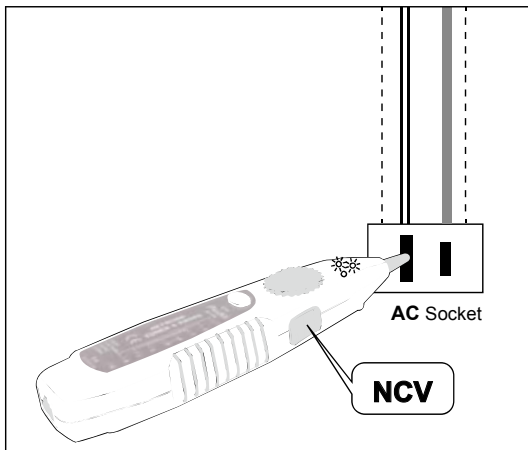

Figure 11 Non Contact Voltage Test

Battery Life and Replacement



Caution

To avoid unreliable test results, replace the battery as soon as the low battery indication appears.



Warning

To avoid possible electric shock or personal injury, turn off the Transmitter or Receiver and disconnect all test leads before replacing the battery.

Battery Status: "**BAT LOW**" LED lights up on the Transmitter indicates the voltage is under 6.5V for powering up the device.

To replace the battery, do the following (Fig 12):

1. Turn off the Transmitter or Receiver and disconnect all test leads before replacing the battery.
2. Properly installed in the case to power the Transmitter and Receiver.
3. Use only a 9V (6FF22) battery.

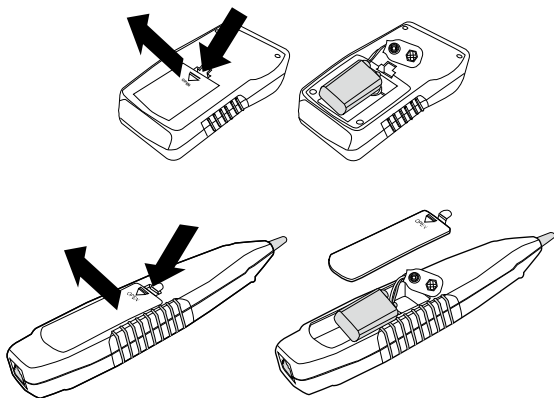

Figure 12 Replacement of the Battery

Maintenance & Trouble shooting :



Warning

Turn off the Transmitter or Receiver and disconnect all test leads before replacing the battery.



Caution

To avoid damaging the case, do not use solvents or abrasive cleansers. Clean the case with a soft cloth dampened with water or a mild soap solution.

Trouble shooting

Possible Problems	Trouble shooting
The signal from transmitter can not be detected by receiver	1.Shortage of battery power: Check the batter on both transmitter and receiver. If the battery voltage is less than 6.5V, please replace with a new battery.
	2.Make sure the switch position on receiver is "OFF" or "LED". The SCAN function will not work if the switch is at "NCV" position.
	3.Device damaged: please return the product to the place you purchased the product for maintenance.
No signal received from transmitter on Live telecommunication device testing	There might be conflict between the signal from telephone office and the signal from transmitter. Please turn off the telephone exchange device.
Incorrect cable mapping result	LED indicator broken: please return the product to the place you purchased the product for maintenance.
	Improper connection of networking or telephone cables: please reconnect the cables toRJ45/ RJ11 compatible connectors.
Others	Device damaged: please return the product to the place you purchased the product for maintenance.

MT-7028 音頻網路測試器

使用說明書

感謝您購買和使用 **Pro'sKit MT-7028 音頻網路測試器**，使用本儀器前請仔細閱讀說明書，閱讀後請妥善保存，以備日後查閱。

目錄：

特點概述.....	24
產品特點.....	25
功能介紹.....	26
包裝內容.....	26
產品規格.....	26
安全資訊.....	27
MT-7028 音頻產生器外觀圖.....	28
MT-7028 接收器外觀圖.....	30
使用 1KHz 音頻信號查找、分離電線.....	31
查找電線.....	32
分離電線.....	34
線對表(Cable Map)測試.....	34
工作中的網路檢測.....	38
同軸電纜線和電線連通測試.....	39
電話正負極性測試.....	40
NCV 非接觸驗電.....	41
電池狀態與電池更換.....	42
維護與簡易故障排除.....	43

特點概述：

MT-7028音頻網路測試器能定位、分離、導通、查找RJ45網路線(UTP、STP、Cat 5e、Cat 6、Cat 7)、RJ11/12電話線(Cat 3)，且能使用戶確認並診斷電纜，佈線的通路、短路、斷路、交叉...等現象，並確認接線順序線號(線對表(Cable Map)和電話線的接線極性。還提供視覺和音頻信號強度指示，使測試距離與精確度更容易精準掌握。和測試一般電線接觸不良所產生的阻抗過大(>300Ω)的問題。**MT-7028音頻網路測試器**提供了完整的配件，讓用戶可以輕易的檢測RJ45插座、RJ45連接線、RJ11插座、RJ11連接線，並具有鱷魚夾，可應用於測試同軸電纜線、一般電線和電信/網路接線板。適用於電信、網路、數據通信、有線電視、室內外配線...等專業的裝配、查線、維修工程人員使用。

特點：

尋線長度達 3 公里

- 音頻網路測試器讓你輕鬆尋線，可直接與具有活電的電信設備和路由器連接。

線序/故障最大測試距離達 300 米

- 具有快速/慢速掃描功能可供選擇。
- 顯示各條線芯的線對表(Cable Map)引腳的結果芯電纜的映射。
- 顯示各線序/故障的通路、短路、斷路、交叉的現象和測試屏蔽/非屏蔽線。

非接觸電壓檢測

- 可測試 AC90~1000V 的電壓，特殊的設計，提醒你在進行測試之前，關閉電源。保護設備。

電話極性測試

- 輕鬆識別電話線路的極性。

節能

- 當 1 小時無動作後，自動關機節省電。

功能簡介：

- **MT-7028 音頻產生器**：具有產生 1KHz 的音頻信號和提供雙音調的高/低兩種音色可以選擇；音頻發射最大距離 ≥ 3 公里，配合 MT-7028 接收器的音量大小調整功能，可經由音量大小控制，精確控制查找斷線位置在 10~30cm 範圍內；MT-7028 接收器具有 LED 信號強度指示燈號，使測試距離與精確度更容易精準掌握。
- **MT-7028 音頻產生器**：配合 MT-7028 接收器的兩端 LED 燈號顯示線對表(Cable Map)，可測試 RJ45 網路線、RJ11 電話線的通路、短路、斷路、交叉的現象和測試屏蔽/非屏蔽線，線纜故障測試最大長度 300 米。
- **MT-7028 音頻產生器**：具有測試一般電線阻抗($>300\Omega$)的 LED 燈號指示，可輕易檢出電線接觸不良的問題。
- **MT-7028 音頻產生器**：具有交流 60V 或 直流 48V 保護，可在活電下測試電信設備和路由器，不必關閉電源，可辨識電話線路的正負極性。
- **MT-7028 音頻產生器**：具有 1 小時無動作自動關機和電池低電壓指示功能。
- **MT-7028 接收器**：具有非接觸驗電(NCV) 交流 90~1000V，可預先測試設備、線路的電壓，避免觸電危險或損壞設備。
- **MT-7028 接收器**：具有 LED 照明和耳機插座，提供給任何吵雜、光線不足的環境使用。
- **MT-7028 音頻網路測試器**：可以配合 RJ45/RJ11 兩用插座，測試 RJ45 網路線和 RJ11 電話線、搭配跳接線可以測試 RJ45/RJ11 插座的接線，搭配鱷魚夾連接線，可測試同軸電纜線、一般電線和各種接線板。

包裝內容：

MT-7028音頻網路測試器的附件如下。若發現有東西損壞或缺少，請立即與購買處聯繫。

- MT-7028音頻產生器。
- MT-7028接收器。
- RJ45(8 pin)至RJ45(8 pin)轉接線。
- RJ11(6 pin)至RJ11(6 pin)轉接線。
- RJ11(6 pin)對鱷魚夾線。
- 耳機。
- 攜存袋。
- 使用手冊。

產品規格：

MT-7028 音頻產生器 規格	
音頻發射頻率	1kHz
音頻最大測試距離	≥3 公里
線序/故障最大測試距離	300 米
最大工作電流	≤65mA
音色	高/低 雙音調
可測試連接埠	RJ45(8 pin)/RJ11(6 pin)兩用插座，提供 RJ45/RJ11 線對測試和 RJ45 音頻尋線用；RJ11(6 pin)插座，提供 RJ11(6P/6C/4C/2C)音頻尋線用。
適用電纜線	RJ45 網路線 Cat 5、5e、6、7 (UTP/STP)、RJ11/12 電話線 Cat 3 (6P/2C/4C/6C)
功能選擇	5 個按式開關 (電源、尋線、線對、短路、電話正/負極性)
短路/導通測試	1 個 LED ($\leq 300\Omega$)，同軸電纜線和一般單芯/多芯絞線用鱷魚夾線測試
輸出信號電壓	8Vp-p
線序/故障指示	8 個 LED，快/慢雙速測試
網路線 屏蔽/非屏蔽指示	1 個 LED
電話線 正/負極性指示	1 個雙色 LED
電信設備和路由器活電測試	有
電壓保護	交流 60V 或 直流 48V
自動關機	約 1 小時
電池低壓指示	6.5V (電源指示燈閃爍)
電池	DC 9.0V (NEDA 1604/ 6F22 DC9V × 1pcs)
外觀尺寸 (長×寬×高)	138×80×35 mm

重量	140 公克
MT-7028 接收器 規格	
音頻接收頻率	1kHz
最大工作電流	≤ 50mA
可測試連接埠	RJ45(8 pin)/RJ11(6 pin) 共用插座
功能選擇	3 段滑動開關(非接觸驗電、關機、LED 照明)
耳機座	1 個
信號強弱指示	1 個 LED & 蜂鳴器
線序/故障指示	8 個 LED
網路線 屏蔽/非屏蔽指示	1 個 LED
非接觸驗電(NCV)指示	1 個 LED (交流 90~1000V)
工作照明	1 個 LED
電池	DC 9.0V (NEDA 1604/ 6F22 DC9V ×1pcs)
外觀尺寸 (長×寬×高)	198×45×33 mm
重量	80 公克

主機跌落測試：1 米。

工作溫度：0 ~ 50°C (32 ~ 122°F)

儲存溫度：-10 ~ 60°C (14 ~ 140°F)

工作濕度：20% - 75% 相對溼度





儲存濕度：10% - 90% 相對溼度

操作高度：3,000 米

儲存高度：10,000 米

安全資訊：

表 1. 描述測試儀上或本手冊中，所使用的國際電氣符號。

	警告：有人身傷害危險。請參閱手冊中的解釋。 小心：有損害或損壞裝置或軟體的危險。請參閱手冊中的解釋。
	警告：有觸電危險。
	注意：須注意操作時的狀態或功能。
	本設備不可連接至公用通信網路，如帶電的電話系統。

警告

- 不得在超過AC 60V/DC 48V的帶電電路上使用本產品。
- 不得使用已破損的MT-7028音頻網路測試器測試導線。使用以前，

- 在測試電話電路時，將不使用的測試導線和連接器從MT-7028音頻網路測試器上斷開連接。
- 除非要更換電池或保險絲，否則不得打開機殼；其中沒有任何用戶可維修的零件。
- 在更換電池以前，請關機！並斷開所有測試導線的連接。
- 僅使用9V電池，正確安裝在機殼內以提供電源。
- 如果不遵照指定方式使用本設備，則可能影響本產品提供的保護。

MT-7028 音頻產生器外觀圖

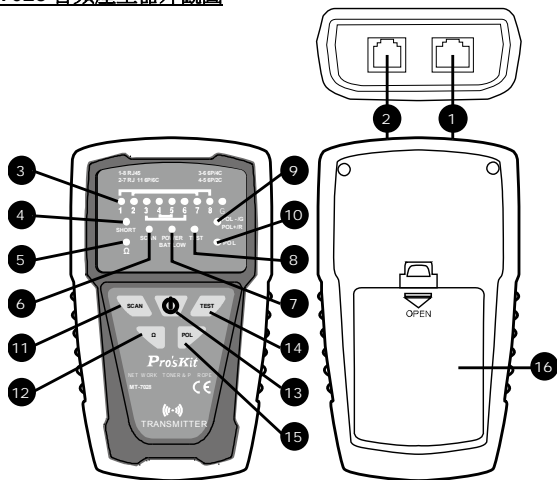

(圖一) MT-7028 音頻產生器 外觀圖

1. **RJ45(8 pin)/RJ11(6/4/2 pin)兩用插座：**提供RJ45/RJ11線序/故障測試用、RJ45音頻尋線用。當在RJ45/RJ11線序/故障測試時，需與MT-7028接收器的RJ45(8 pin)/RJ11(6/4/2 pin)兩用插座，共同搭配使用。



注意！任何具有活電的線路，不可插入本插座中！RJ11電話線的音頻尋線不可使用本插座。

2. **RJ11(6 pin)插座**：僅提供RJ11(6P/6C/4C/2C)音頻尋線用。



注意！在超過AC 60V/DC 48V的活電的線路，不可插入本插座中！

3. 「1~8、G」**測試結果指示燈**：RJ45/RJ11的線對表(Cable Map)和線序/故障的8個LED指示燈和屏蔽線/非屏蔽線測試結果指示，需與接收器的燈號搭配使用。
4. 「SHORT」**短路測試結果指示燈**：當指示燈亮起時，表示線路阻抗 < 300Ω或短路。當指示燈不亮時，表示線路阻抗 > 300Ω或斷路(開路)。
5. 「Ω」**短路/導通功能指示燈**：按下「Ω」短路/導通功能鍵時，指示燈亮起，表示短路/導通測試的功能啟動。
6. 「SCAN」**尋線功能指示燈**：按下「SCAN」尋線功能鍵時，當指示燈慢速閃爍時，表示低音調尋線測試的功能啟動。再按一下「SCAN」尋線功能鍵時，當指示燈快速閃爍時，表示高音調尋線測試的功能啟動。
7. 「POWER/BAT LOW」**電源指示燈**：按下「」電源開/關鍵時，指示燈亮起，表示電源開啟，再按其他功能鍵時，才能啟動測試功能。當指示燈閃爍時，表示電池電壓低於6.5V，需要更換電池。
8. 「TEST」**線序/故障功能指示燈**：按下「」線序/故障功能鍵時，當指示燈慢速閃爍時，表示線序/故障慢速測試的功能啟動。再按一下「」線序/故障功能鍵時，當指示燈快速閃爍時，表示線序/故障快速測試的功能啟動。
9. 「POL- /G, POL+ /R」**電話極性測試結果指示燈**：這是一個紅/綠雙色LED指示燈，當紅色指示燈亮起時，代表紅色鱷魚夾接的是正極，黑色鱷魚接的是負極。當綠色指示燈亮起時，代表紅色鱷魚夾接的是負極，黑色鱷魚接的是正極。當指示燈不亮時，代表電話線路無供電。
10. 「POL」**電話極性功能指示燈**：按下「」電話極性功能鍵時，指示燈亮起，表示電話正/負極性測試的功能啟動。
11. 「」**尋線功能鍵**：按下此功能鍵後，當「SCAN」尋線功能指示燈閃爍時，表示低音調尋線測試的功能啟動。再按一下此功能鍵後，當「SCAN」尋線功能指示燈快速閃爍時，表示高音調尋線測試的功能啟動。
12. 「」**短路/導通功能鍵**：按下此功能鍵後，當「Ω」短路/導通功能指示燈亮起時，表示短路/導通測試的功能啟動。
13. 「」**電源開/關鍵**：按下此鍵後，當「POWER/BAT LOW」電源指示燈亮起時，表示電源開啟。再按一下此鍵時，當「POWER/BAT LOW」電源指示燈熄滅後，表示電源關閉。

14. 「**TEST**」線序/故障功能鍵：按下此功能鍵後，當「TEST」線序/故障功能指示慢速燈閃爍時，表示慢速線序/故障測試的功能啟動。再按一下此功能鍵後，當「TEST」線序/故障功能指示燈快速閃爍時，表示快速線序/故障測試的功能啟動。
15. 「**POL**」電話極性功能鍵：按下此功能鍵後，當「POL」電話極性功能指示燈亮起時，表示電話正/負極性測試的功能啟動。
16. 電池蓋。

8 · MT-7028 接收器 外觀圖：

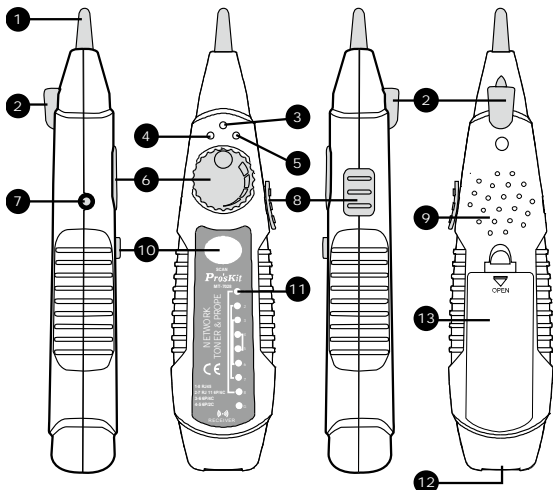

(圖二) MT-7028 接收器 外觀圖

1. **音頻信號探頭**：「SCAN」尋線功能或是非接觸驗電(NCV)測試功能的探頭。
2. **LED工作照明燈**：當工作環境光線不足時，可作為輔助照明使用。
3. **電源指示燈**：當3段功能選擇開關，撥切至「LED」或「NCV」檔位時，指示燈亮起，表示「LED」或「NCV」測試的功能啟動。當3段功能選擇開關，撥切至「OFF」檔位時，按下「**SCAN**」尋線功能鍵時，指示燈亮起，表示尋線測試的功能啟動。

4. **非接觸驗電(NCV)指示燈**：將音頻信號探頭靠近被測物，進行非接觸驗電(NCV)測試，當此指示燈快速閃爍時，代表被測物具有90~1000V交流電壓。當指示燈不亮時，代表被測物的交流電壓低於90V或是沒有交流電壓。
5. **信號強弱指示燈**：將音頻信號探頭靠近被測物，進行尋線功能測試，當此指示燈越亮，表示信號越強。
6. **音量旋扭**：控制音量由大到小，則可以改變查找電線的靈敏度，將搜尋位置由30cm縮小到10cm以內，精確找到目標芯線的位置。
7. **ø3.5mm耳機座**：當工作環境噪音太大時，可插入耳機，方便尋線測試使用。
8. **3段功能選擇開關**：3段滑動開關(非接觸驗電NCV、關機OFF、工作照明LED)
9. **喇叭**：當尋線(SCAN)測試的功能啟動後，喇叭聲音越大，表示信號越強。
10. **「SCAN」尋線功能鍵**：當按下此尋線功能鍵時，電源指示燈亮起，表示尋線測試的功能啟動。
11. **「1~8、G」測試結果指示燈**：RJ45/RJ11的線對表(Cable Map)和線序/故障的8個LED指示燈和屏蔽線/非屏蔽線測試結果指示，需與音頻產生器的燈號搭配使用。
12. **RJ45(8 pin)/RJ11(6/4/2 pin)兩用插座**：提供RJ45/RJ11線序/故障測試的遠端器用。需與MT-7028音頻產生器的RJ45(8 pin)/RJ11(6/4/2 pin)兩用插座，共同搭配使用。



注意！任何具有活電的線路，不可插入本插座中！

13. 電池蓋。

9 · 使用1KHz音頻信號查找、分離電線：

使用MT-7028音頻網路測試器的1KHz查找線路時，能定位、分離、查找雙絞線(UTP、STP、Cat 5e、Cat 6)、電話線(Cat 3)，搭配跳接線可以測試RJ45/RJ11插座的接線，搭配鱷魚夾連接線，可測試同軸電纜線、一般電線和各種接線板。



警告

- 使用MT-7028音頻網路測試器不可以使用在帶電的線路上，操作前應確實關閉所有電源。
- RJ45音頻尋線時，請使用RJ45(8 pin)/RJ11(6/4/2 pin)兩用插座。RJ11(6P/6C/4C/2C)音頻尋線時，請使用RJ11(6 pin)插座。使用RJ11(6 pin)插座，搭配鱷魚夾連接線，可測試同軸電纜線、一般電線和各種接線板。





注意

- 使用MT-7028音頻網路測試器的1KHz查找線路時，應儘量遠離或關閉干擾源。如.具有變壓器、電感、線圈、馬達的電器設備等；如果接近干擾源，而MT-7028接收器產生接收的雜訊聲音，屬於正常狀態；但如果影響操作判斷時，應予遠離或關閉干擾源。
- MT-7028音頻網路測試器的1KHz音頻信號，通過電路機板或分岔線路或整捆電線(絞線)時，會有相互感應傳遞和信號強度的衰減的現象。且無法穿透金屬配線管。
- 在搜索MT-7028音頻產生器的信號時，沒有必要將MT-7028接收器的探頭觸及纜纜或接線板。
- 在使用MT-7028音頻網路測試器前，應確實檢查MT-7028音頻發射器的黑色鱷魚夾，確實接地妥善。

MT-7028音頻產生器所產生1KHz的音頻信號，具有雙音調高/低兩種音色可以選擇，並可以配合所有連接介面和配件，提供這兩種高/低音頻信號。

查找電線

當你需要查找電線佈線位置或查找電線斷路位置時，請依照下列步驟(如圖三)進行：

1. 如(圖三)所示，先將MT-7028音頻產生器 的黑色鱷魚夾確實接地，再將紅色鱷魚夾與待測線路的連接線或插座或接線板連接妥善。
2. 如(圖三)所示，按下「」電源開/關鍵，「POWER/BAT LOW」紅色電源指示燈亮起，打開電源。再按下「」尋線功能鍵後，當「SCAN」尋線功能紅色指示燈閃爍時，表示低音調尋線測試的功能啟動。再按一下此功能鍵後，當「SCAN」尋線功能紅色指示燈快速閃爍時，表示高音調尋線測試的功能啟動。再按一下此功能鍵後，當「SCAN」尋線功能紅色指示燈熄滅後，表示回到待機狀態。
3. 如(圖三)所示，要接收1KHz且有聲音輸出，按下MT-7028接收器的「」尋線功能鍵時，紅色指示燈亮起，表示尋線測試的功能啟動。當放開「」尋線功能鍵時，紅色指示燈熄滅後，表示尋線測試的功能關閉。未插上耳機前喇叭有聲音輸出，插上耳機後則喇叭無聲音輸出，聲音由耳機輸出。
4. 使用MT-7028接收器 將音量旋鈕轉到最大，沿著塑膠配線管、走線架、接線板或牆壁，查找佈線線路的大致位置。接近時，MT-7028接收器 的喇叭響起音頻信號聲音，喇叭聲音越大，表示信號越強；同時信號強弱指示燈LED亮紅色，LED指示燈明暗程度會隨信

5. 旋轉音量旋鈕，控制音量由大到小，則可以改變查找電線的靈敏度，將搜尋位置由30cm縮小到10cm以內，精確查找到電線。

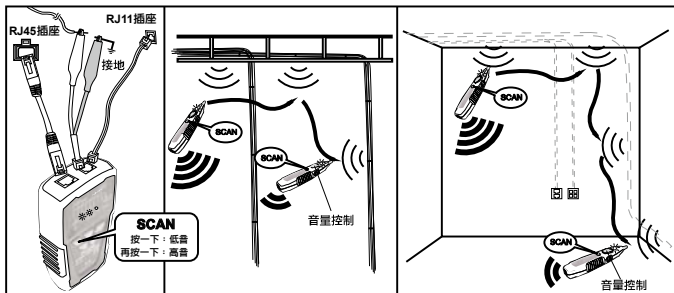

(圖三) 查找電線

分離電線

當你需要尋找網綁在一起的電纜其中一條電線，或多芯電纜中的其中一條芯線時，請依照前面查找電線的步驟(1.)到(4.)進行(如圖三)，然後再依照下列步驟(如圖四)繼續進行：

6. 將電纜撥開約30~45cm長，採用二分法，將電纜的芯線概略分為左右各一半，使用MT-7028接收器尋找目標芯線的位置，喇叭聲音較大和LED燈比較亮(信號較強)的一邊，代表其中包含了你所要尋找的目標芯線。
7. 旋轉音量旋鈕，控制音量由大到小，則可以改變查找電線的靈敏度，將搜尋位置由30cm縮小到10cm以內，精確找到目標芯線的位置。
8. 重複前面二分法的(5.)、(6.)步驟，則可輕易找到目標芯線。



注意

如果不能正確分辨兩導線電纜上的音頻信號，可能電纜已短路或斷路。請使用連通測試，檢查接電纜是否短路或斷路。

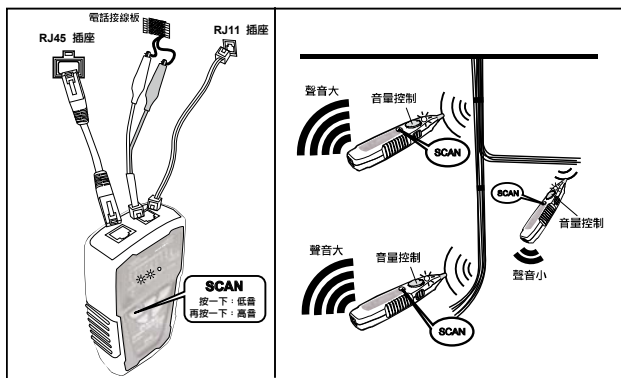

(圖四) 分離電線

10 · 線對表(Cable Map)測試：

可以使用MT-7028音頻產生器和MT-7028接收器配合RJ45/RJ11兩用插座，測試RJ45網路線和RJ11電話線的線對表(Cable Map)。搭配跳接線可以測試RJ45/RJ11插座的線對表(Cable Map)。線對表(Cable Map)的功能可查找各種電纜佈線上常見的：通路、短路、斷路、交叉的情況。



注意

RJ45或RJ11線對表(Cable Map)測試時，音頻產生器的接頭，只能

使用RJ45/RJ11兩用插座，不可使用RJ11(6 pin)插座。

1. 依(圖五)所示，將MT-7028音頻產生器和MT-7028接收器妥善連接RJ45(8P/8C)、RJ11(6P/6C、6P/4C、6P/2C)的待測線路的連接線或插座。
2. 按下「」電源開/關鍵，「POWER/BAT LOW」紅色電源指示燈亮起，打開電源。再按下MT-7028音頻產生器的「」線序/故障功能鍵後，當「TEST」線序/故障功能綠色指示燈慢速閃爍時，表示慢速線序/故障測試的功能啟動，線對表(Cable Map)的紅色LED開始慢速掃描顯示。再按一下「」線序/故障功能鍵後，當「TEST」線序/故障功能綠色指示燈快速閃爍時，表示快速線序/故障測試的功能啟動，線對表(Cable Map)的紅色LED開始快速掃描顯示。再按一下此功能鍵後，當「TEST」線序/故障功能綠色指示燈熄滅後，表示回到待機狀態。

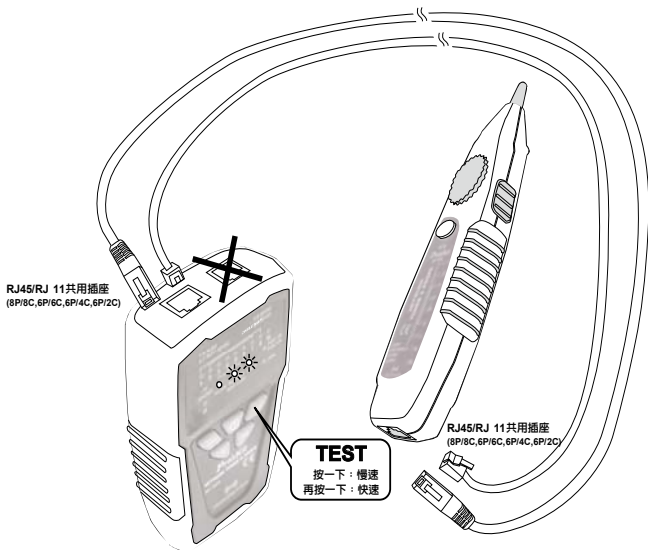

(圖五) 線對表(Cable Map)測試



注意

- 線對表(Cable Map)測試時，LED慢速掃描顯示間隔約1秒鐘，LED快速掃描顯示間隔約0.5秒鐘，每次由1~8、G順序掃描顯示。如果遇到2條空線時，會有間歇2秒的現象，依此類推。
 - 線對表(Cable Map)測試前，如有必要，可依前面所述方式，使用“**查找電線**”的方法，先進行查找另一端正確的連接器或連接線。
3. MT-7028音頻產生器和MT-7028接收器上的LED輸出，不同線材的線對表(Cable Map)顯示方式如下：

- RJ45(8P/8C)的LED燈號顯示：MT-7028音頻產生器的線對表(Cable Map)LED，每1秒由1~8、G的順序，逐步顯示；並依接線順序，對應MT-7028接收器上的線對表(Cable Map)LED同步顯示。(如圖六)
- RJ11(6P/6C、6P/4C、6P/2C)的LED燈號顯示：MT-7028音頻產生器的線對表(Cable Map)LED，6P/6C每1秒由2~7的順序；6P/4C每1秒由3~6的順序；6P/2C每1秒由4~5的順序，逐步顯示；並依接線順序，對應MT-7028接收器上的線對表(Cable Map)LED同步顯示。如果遇到空線時，會有顯示間歇的現象。(如圖六)

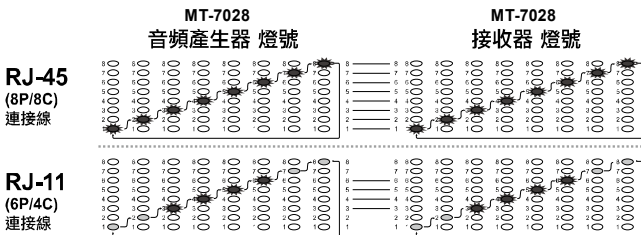

(圖六) 不同線材的線對表(Cable Map)

MT-7028音頻產生器和MT-7028接收器上的線對表(Cable Map)LED輸出

出，通路、短路、斷路、交叉表示的方式如下：

- 「通路」的LED燈號顯示：MT-7028音頻產生器的LED，第1~8、G個LED亮燈，對應MT-7028接收器上的LED，第1~8、G個LED同步顯示。(如圖七)
 - 「短路」的LED燈號顯示：MT-7028音頻產生器的LED，第3個和第4個LED依序亮燈，對應MT-7028接收器上的LED，第3個和第4個LED同時點亮，但亮度較暗。(如圖七)
 - 「斷路」的LED燈號顯示：MT-7028音頻產生器的LED，第3個LED不亮，對應MT-7028接收器上的LED，第3個LED不亮。(如圖七)
 - 「交叉」的LED燈號顯示：MT-7028音頻產生器的LED，第3個LED亮燈，對應MT-7028接收器上的LED，第4個LED同步顯示；MT-7028音頻產生器的LED，第4個LED亮燈，對應MT-7028接收器上的LED，第3個LED同步顯示。(如圖七)
4. 依照MT-7028音頻產生器和MT-7028接收器上的線對表(Cable Map)LED輸出，反覆測試；並以LED顯示的線對表(Cable Map)確認接線順序的正確性。

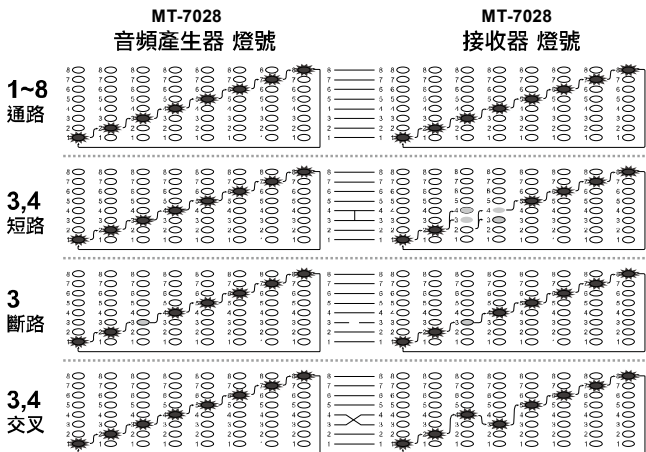

(圖七) 通路、短路、斷路、交叉

11 · 工作中的網路檢測：



注意：此測試方法只能測試網線路通斷，不能檢測交叉或短路。

1. 依(圖八)所示，將MT-7028音頻產生器妥善連接RJ45(8P/8C)網路線或插座、另一端連接在正在工作的網路交換機上。
2. 按下「」電源開/關鍵，「POWER/BAT LOW」紅色電源指示燈亮起，打開電源。再按下MT-7028音頻產生器的「」線序/故障功能鍵後，當「TEST」線序/故障功能綠色指示燈慢速閃爍時，表示慢速線序/故障測試的功能啟動，線對表(Cable Map)的紅色LED開始慢速掃描顯示。再按一下「」線序/故障功能鍵後，當「TEST」線序/故障功能綠色指示燈快速閃爍時，表示快速線序/故障測試的功能啟動，線對表(Cable Map)的紅色LED開始快速掃描顯示。再按一下此功能鍵後，當「TEST」線序/故障功能綠色指示燈熄滅後，表示回到待機狀態。
3. 當MT-7028音頻產生器上的「1~8、G」測試結果指示燈，按先後順序逐一點亮時，表示網路線1~8、G全部連通，如有燈號未亮，代表線路故障。

4.

RJ45 插座

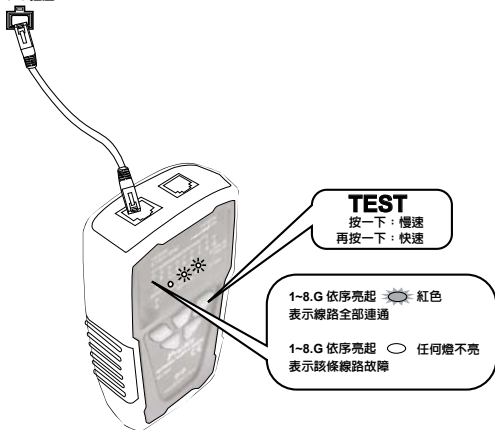



(圖八) 接入工作中的網路檢測

12 · 同軸電纜線和電線連通測試：



警告：測試前，應先確認並關閉電源。

當你需要確認同軸電纜線或電線連通是否有接觸不良時，請依照下列步驟(如圖九)進行：

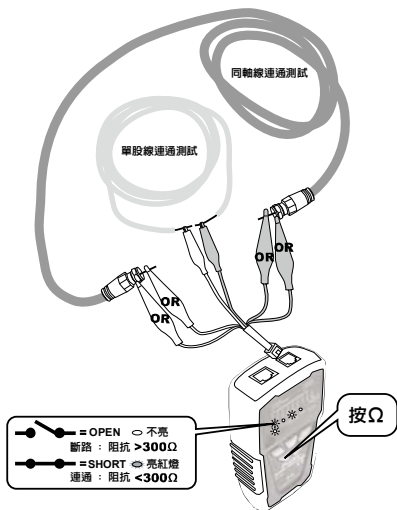

1. 如(圖九)所示，先將MT-7028音頻產生器的黑色鱷魚夾，確實與待測電纜的一端接頭、金屬部分連接妥善，再將紅色鱷魚夾，與待測電纜的另一端接頭、金屬部分連接妥善。
2. 按下「」電源開/關鍵，「POWER/BAT LOW」紅色電源指示燈亮起，打開電源。再按下MT-7028音頻產生器的「」短路/導通功能鍵後，當「 Ω 」短路/導通功能綠色指示燈亮起時，表示短路/導通測試的功能啟動。再按一下此功能鍵後，當「 Ω 」短路/導通功能綠色指示燈熄滅後，表示回到待機狀態。
3. 當「SHORT」短路測試結果紅色指示燈亮起時，表示連通(阻抗 $<300\Omega$)。當指示燈不亮時，表示無連通，或是遮蔽不良和連通不良(阻抗 $>300\Omega$)。



(圖九) 同軸電纜線和電線連通測試

13 · 電話正負極性測試：

當你需要確認電話線路的正負極性時，請依照下列步驟(如圖十)進行：

1. 如(圖十)所示，先將MT-7028音頻產生器的紅、黑色鱷魚夾，分別與待測電話線路的連接線或插座或接線板的兩端連接妥善。
2. 按下「」電源開/關鍵，「POWER/BAT LOW」紅色電源指示燈亮起，打開電源。再按下MT-7028音頻產生器的「」電話極性功能鍵後，當「POL」電話極性功能指示燈亮起時，表示電話正/負極性測試的功能啟動。再按一下此功能鍵後，當「POL」電話極性功能指示燈熄滅後，表示回到待機狀態。
3. 「POL - /G, POL + /R」電話極性測試結果指示燈，是一個紅/綠雙色LED指示燈：
 - 紅色指示燈亮起時，代表紅色鱷魚夾端為電話局線的“+”極，黑色鱷魚夾端為電話局線的“-”極。
 - 綠色指示燈亮起時，代表紅色鱷魚夾端為電話局線的“-”極，黑色鱷魚夾端為電話局線的“+”極。
 - 當指示燈不亮時，代表電話線路無供電或是線路故障。

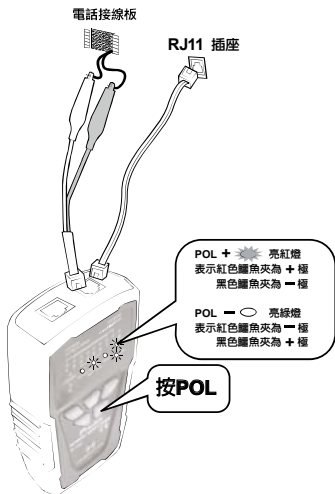

(圖十) 電話正負極性測試

14 · NCV 非接觸驗電：



注意：

此項測試功能可以被廣泛應用在定位、分離、導通、查找、線對表(Cable Map)測試前，確認被測線路中是否有交流電壓？除可確保人身安全.避免觸電外，也可以保護MT-7028音頻網路測試器，不被交流電壓損壞！

1. 如(圖十一)所示，將3段功能選擇開關(非接觸驗電NCV、關機OFF、工作照明LED)，撥切至「NCV」檔位後，電源指示燈亮起，表示「NCV」非接觸驗電測試的功能啟動。
- 2.
3. 將MT-7028接收器的探頭靠近被測物，進行非接觸驗電(NCV)測試，當非接觸驗電(NCV)指示燈快速閃爍、同時蜂鳴警報時，代表被測物具有90~1000V交流電壓。當指示燈不亮、無蜂鳴警報時，代表被測物的交流電壓低於90V或是沒有交流電壓。

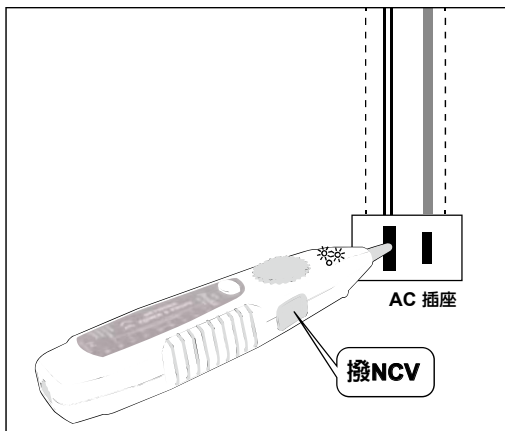

(圖十一) NCV 非接觸驗電測試

15 · 電池狀態與電池更換：



小心

為避免測試結果不可靠，一旦出現電池不足的指示，請立即更換電池。



警告

為避免可能發生的電擊或人體傷害，更換電池前，應關機並斷開所有測試導線的連接。

當MT-7028音頻產生器的「POWER/BAT LOW」電源指示燈閃爍時，代表電壓已低於6.5V，為了確保測試器處於最佳工作狀態和提供準確的測試，應立即更換新電池。更換電池請依下列步驟進行：(如圖十二)

1. 關機，並斷開所有測試導線的連接。
2. 如(圖十二)所示，輕輕打開電池盒蓋，取出電池，並輕力取下電池扣。
3. 換上新的9V電池(6FF22)，輕力扣上電池扣，放入電池，蓋上電池盒蓋。

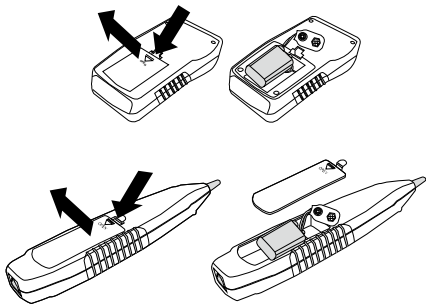

(圖十二) 電池更換

16 · 維護與簡易故障排除：

維護：



警告

為避免可能發生的電擊或人體傷害，維護前，應關機並斷開所有測試導線的連接。



小心

為避免損壞機殼，不要使用溶劑或磨蝕性去污粉。

用柔性軟布沾水後擰乾、或柔性軟布沾柔性皂液後擰乾，輕輕的擦拭機殼。

簡易故障排除：

故障	排除
接收器無法探測音頻產生器的信號	4. 電池電力不足：檢查音頻產生器和接收器的電池，如電壓低於 6.5V，需更換電池。
	5. 接收器檔位不正確：請撥至 OFF 或 LED 檔，NCV 檔不能探測 SCAN 信號。
	6. 儀器故障：返回經銷商維修。
活電下測試電話局線，接收器無法探測音頻產生器的信號	可能是電話局線信號頻率，與本音頻產生器的信號衝突，請關閉電話交換機。
線序/故障測試結果顯示不正確	LED 指示燈損壞：返回經銷商維修
	網路線或電話線接觸不良：請將網路線或電話線，重新插入 RJ45/RJ11 共用插座。
其它功能異常	儀器故障：返回經銷商維修



寶工實業股份有限公司
PROKIT'S INDUSTRIES CO., LTD.

<http://www.prokits.com.tw>

E-mail : pk@mail.prokits.com.tw

©2014 Prokit's Industries Co., LTD. All rights reserved 2014001(C)