

AC Filter 2-Stage, Very High Symmetrical Attenuation



Description

- Line-filter in standard version
- 2 positions
- very high attenuation, broadband

Approvals

- VDE Certificate Number: 40004673
- UL File Number: E72928

Characteristics

- Designed for increased requirements
- 2-stage line filter with increased attenuation
- Protection against interference voltage from the mains
- Possible interferences generated in the equipment are strongly attenuated
- Especially suitable for use in switching power supplies e.g. in electronic designs with high repetitive switching frequency
- Suitable for use in equipment according to IEC/UL 60950

References

Alternative: Standard version

Weblinks

[pdf datasheet](#), [html-datasheet](#), [General Product Information](#), [Approvals](#), [CE declaration of conformity](#), [RoHS](#), [CHINA-RoHS](#), [REACH](#), [Distributor-Stock-Check](#), [Detailed request for product](#)

Technical Data

Ratings IEC	1 - 16A @ Ta 40 °C / 250VAC; 50Hz
Ratings UL/CSA	1 - 16A @ Ta 40 °C / 125/250VAC; 60Hz
Leakage Current	industrial < 1.4mA (250V / 60Hz)
Dielectric Strength	> 1.7kVDC between L-N > 2.7kVDC between L/N-PE Test voltage (2 sec)
Allowable Operation Temperature	-25 °C to 100 °C
Climatic Category	25/100/21 acc. to IEC 60068-1
Protection Class	Suitable for appliances with protection class I acc. to IEC 61140
Terminal	Quick connect terminals 6.3 x 0.8 mm or screw terminals
Material: Housing	Aluminum

Line Filter	Standard and Industrial Version, IEC 60939, UL 1283, CSA C22.2 no. 8 Technical Details
MTBF	> 200'000h acc. to MIL-HB-217 F

Detailed information on product approvals, code requirements, usage instructions and detailed test conditions can be looked up in [General Product Information](#)

Dimension

Case 10

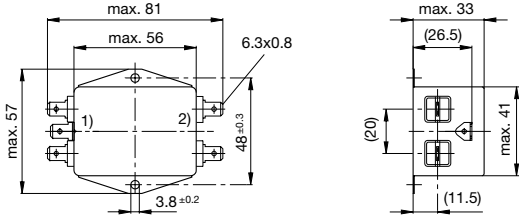

1) Line
2) Load

Case 19

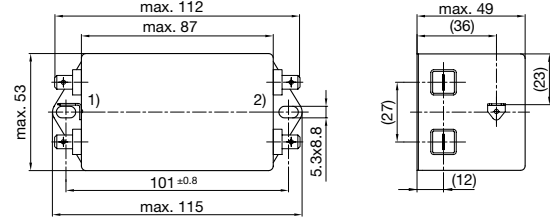

1) Line
2) Load

Case 27

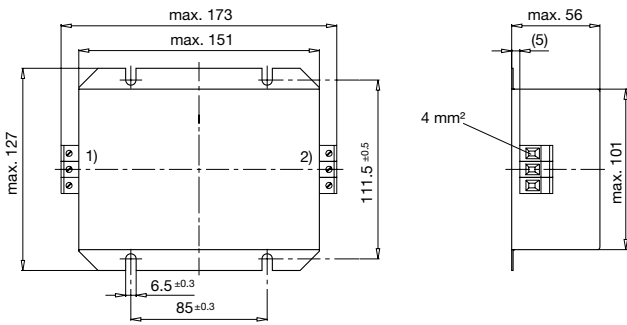

1) Line
2) Load

Case 48

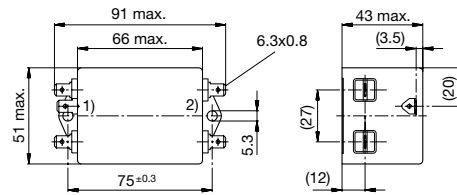

1) Line
2) Load

Diagrams

Standard version

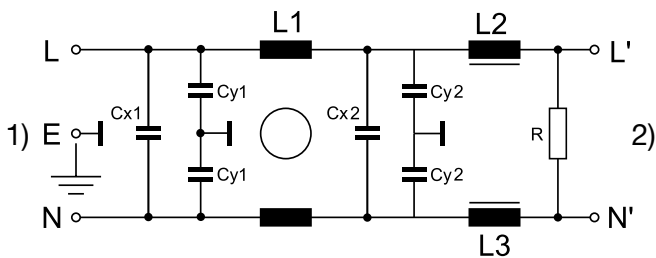

1) Line
2) Load

Attenuation Loss

----- 50Ω differential mode _____ 50Ω common mode

Standard version

1 A

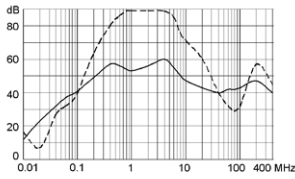

2 A

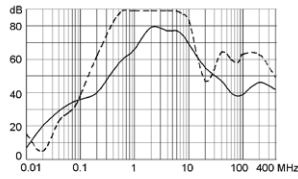

3 A

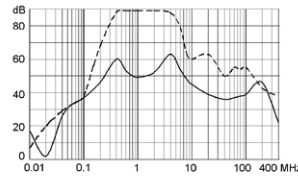

Industrial version

4 A

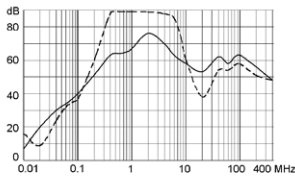

6 A

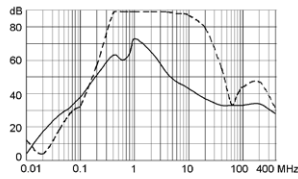

10 A

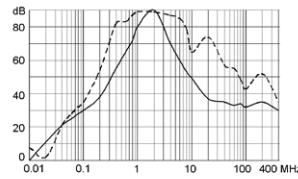

16 A

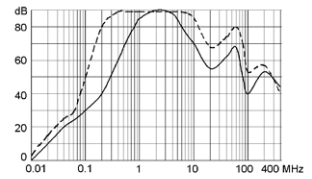

Rated Current [A]	Filter-Type	Leakage Current [mA]	L1 [mH]	L2 [mH]	L3 [mH]	Cx1 [µF]	Cx2 [µF]	Cy1 [nF]	Cy2 [nF]	R [MΩ]	Weight [g]	Housings	Order Number
1	Standard Version	0.25	2 x 15	1	-	0.1	0.47	1.5	1	1	121 g	10	5500.2051
2	Standard Version	0.25	2 x 10	0.4	0.4	0.1	0.47	1.5	1	1	121 g	10	5500.2052
3	Standard Version	0.25	2 x 12	1	-	0.1	0.68	1.5	1	1	275 g	48	5500.2053
4	Industrial Version	1.4	2 x 10	0.8	-	0.1	0.68	10	4.7	1	275 g	48	5500.2054
6	Industrial Version	1.4	2 x 6	0.5	-	0.1	0.68	10	4.7	1	284 g	48	5500.2055
10	Industrial Version	1.4	2 x 5	0.2	0.2	0.1	1	10	4.7	1	529 g	19	5500.2056
16	Industrial Version	1.4	2 x 4	0.2	0.2	0.47	2.2	10	4.7	1	2000 g	27	5500.2057

Most Popular.

Availability for all products can be searched real-time: <http://www.schurter.com/en/Stock-Check/Stock-Check-SCHURTER>

Packaging unit 10 Pcs

Mouser Electronics

Authorized Distributor

Click to View Pricing, Inventory, Delivery & Lifecycle Information:

Schurter:

[5500.2052](#) [5500.2051](#) [5500.2056](#) [5500.2055](#) [5500.2054](#) [5500.2053](#) [5500.2057](#)