

Filter elements for the installation into Hydac filter housings

Type 9. and 10. filter elements

RE 51457

Edition: 2017-02

Replaces: 06.15



filter_53_gruppe

- ▶ Installation in return flow filters (R)
- ▶ Installation in inline filters (D)
- ▶ Frame sizes: 30-1500 (model D)
- ▶ Frame sizes: 30-2600 (model R)
- ▶ Pressure differential resistance up to 210 bar [3045 psi]

Features

- ▶ Filter media
 - Glass fiber material of the 5th product generation with electrically conductive non-woven medium and increased dirt holding capacity
 - Glass fiber material with water-absorbing function
 - Additional filter media: Filter paper, wire mesh, non-woven material and non-woven metal fiber for numerous fields of application in fluid filtration.
- ▶ Extended product range for non-mineral oil based fluids

Contents

Features	1
Ordering code	2 ... 6
Function, section	7
Filter variables	8
Filter media	9 ... 14
Technical data	10
Admissible operating temperature range, depending on material combination	10
Compatibility with permitted hydraulic fluids	10
Installation, commissioning, maintenance	15
Directives and standardization	15
Environment and recycling	16

Ordering code

Filter element type 9.

01	02	03	04	05	06
9.			-	-	0

Filter element

01	Design	9.
----	--------	----

Size

02	According to Hydac size	30
		60
		110
		140
		160
		240
		0260
		280
		0300
		330
		500
660		

Filter rating in µm

03	Absolute (ISO 16889)	Glass fiber material generation 5, non-reusable (not cleanable)	H1XL	
			H3XL	
			H6XL	
			PWR10	
			H20XL	
	Nominal	Stainless steel wire mesh, cleanable	G10	
			G25	
			G40	
			G60	
			G100	
			Filter paper, non-reusable (not cleanable)	P10
				P25

Pressure differential

04	Maximum admissible pressure differential of the filter element 30 bar [435 psi]	A00
	Maximum admissible pressure differential of the filter element 210 bar [3000 psi]	F00

Bypass valve

05	Without bypass valve	0
----	----------------------	---

Seal

06	NBR seal	M
	FKM seal	V

Other versions available upon request.

Order example:

9.240 PWR10-A00-0-M

Material no.: R928017227

Filter element search with **Fit4Filter** available as Rexroth App (download at the Apple App Store or Google Play Store) **or** as Rexroth online software at www.boschrexroth.de/filter.

Ordering code

Filter element type 9.

01	02	03	04	05	06	07
9.			-	0	-	

Filter element

01	Design	9.
----	--------	----

Size

02	According to Hydac size	30LA
		0035LA
		0055LA
		60LA
		0075LA
		0095LA
		110LA
		140LA
		160LA
		240LA
		280LA
		330LA
		500LA
		660LA
990LA		
1320LA		
1500LA		

Filter rating in µm

03	Absolute (ISO 16889)	Glass fiber material generation 5, non-reusable (not cleanable)	H1XL
			H3XL
			H6XL
			PWR10
			H20XL
	Nominal	Stainless steel wire mesh, cleanable	G10
			G25
			G40
			G60
			G100
		Filter paper, non-reusable (not cleanable)	P10
			P25

Pressure differential

04	Maximum admissible pressure differential of the filter element 30 bar [435 psi]	A00
	Maximum admissible pressure differential of the filter element 210 bar [3000 psi]	F00

Bypass valve

05	Without bypass valve	0
----	-----------------------------	---

Seal

06	NBR seal	M
	FKM seal	V

Amending information

07	Protective cage	SO3000 ¹⁾
----	-----------------	----------------------

Other versions available upon request.

Order example:

9.240LA PWR10-A00-0-M SO3000

Material no.: R928017243

¹⁾ Protective cage SO3000 only in connection with filter material H...XL or AS...

Filter element search with **Fit4Filter** available as Rexroth App (download at the Apple App Store or Google Play Store) or as Rexroth online software at www.boschrexroth.de/filter.

Ordering code

Filter element type 10.

01	02	03	04	05	06
10.			- A00	-	-

Filter element

01	Design	10.
----	--------	-----

Size

02	According to Hydac size	30
		60
		110
		160
		240
		330
		500
		660
		850
		950
		1300
		2600

Filter rating in µm

03	Absolute (ISO 16889)	Glass fiber material generation 5, non-reusable (not cleanable)	H1XL
			H3XL
			H6XL
			PWR10
			H20XL
	Nominal	Stainless steel wire mesh, cleanable	G10
			G25
			G40
			G60
			G100
	Water-absorbing	Non-reusable (not cleanable)	Filter paper, non-reusable (not cleanable)
			P10
			P25
		AS3 ¹⁾	
		AS10 ¹⁾	

Pressure differential

04	Maximum admissible pressure differential of the filter element 30 bar [435 psi]	A00
----	---	-----

Bypass valve

05	Standard cracking pressure 3 bar [44 psi]	6
	Cracking pressure 6 bar [87 psi]	B6
	Without bypass valve	0

Seal

06	NBR seal	M
	FKM seal	V

Other versions available upon request.

¹⁾ AS filter material, configurable from size 330

Order example:

10.1300 PWR10-A00-6-M

Material no.: R928017657

Filter element search with **Fit4Filter** available as Rexroth App (download at the Apple App Store or Google Play Store) **or** as Rexroth online software at www.boschrexroth.de/filter.

Ordering code

Filter element type 10.

01	02	03	04	05	06	07
10.			- A00 -			

Filter element

01	Design	10.
----	--------	------------

Size

02	According to Hydac size	30LA
		60LA
		75LA
		110LA
		160LA
		165LA
		4071LA
		240LA
		280LA
		330LA
		500LA
		660LA
		850LA
		950LA
1300LA		
1700LA		
2600LA		

Filter rating in µm

03	Absolute (ISO 16889)	Glass fiber material generation 5, non-reusable (not cleanable)	H1XL
			H3XL
			H6XL
			PWR10
			H20XL
	Nominal	Stainless steel wire mesh, cleanable	G10
			G25
			G40
			G60
			G100
		Filter paper, non-reusable (not cleanable)	P10
			P25
			AS3¹⁾
	Water-absorbing	Non-reusable (not cleanable)	AS10¹⁾

Pressure differential

04	Maximum admissible pressure differential of the filter element 30 bar [435 psi]	A00
----	---	------------

Bypass valve

05	Standard cracking pressure 3 bar [44 psi]	6
	Cracking pressure 6 bar [87 psi]	B6
	Without bypass valve	0

Seal

06	NBR seal	M
	FKM seal	V

Ordering code

Filter element type 10.

01	02	03	04	05	06	07
10.			- A00	-	-	

Amending information

07	Protective cage ²⁾	SO3000
----	-------------------------------	---------------

1) AS filter material, configurable from size 330

2) Protective cage SO3000 only in connection with filter material H...XL or AS...

Other versions available upon request.

Order example:

10.1300LA PWR10-A00-6-M SO3000

Material no.: R928017667

Filter element search with **Fit4Filter** available as Rexroth App (download at the Apple App Store or Google Play Store) **or** as Rexroth online software at **www.boschrexroth.de/filter**.

Function, section

Rexroth filter elements are used for the filtration of hydraulic fluids in the hydraulic system as well as for the filtration of lubricants, industrial fluids and gases. The actual filtration process takes part in the filter element, the central component of an industrial filter. In connection with the filter medium, it defines the main filter variables, such as retention capacity, dirt holding capacity and pressure loss.

6-layer filter material set-up PWR...

The filter element consists of a combination of star-like pleated filter media (3) of the 5th generation. Configuration with a total of 6 layers consisting of 3 filter-efficient glass fiber layers, with conductive non-woven medium and stainless steel mesh on the outlet side by default. The filter layers are laid around a perforated support tube (2). With version SO3000, a perforated protective cage (4) is additionally laid around the filter element mat. In longitudinal direction, the filter element is sealed using a 2-component adhesive and support tube and filter element mat are connected with both end disks (1). The protective cage allows for a continuous fluid flow around the filter element mat and, at the same time, provides mechanical protection against external damage. Seals are provided between the filter element and the filter housing as a sealing. There is generally flow from the outside to the inside.

Zinc-free filter element set-up

All type 9. and 10. filter elements specified in this data sheet are made of zinc-free components thus preventing the formation of zinc-soap, in particular if water-containing fluids (HFA/HFC) and synthetic oils are used. Moreover, many manufacturers of construction and agricultural machinery stipulate the use of zinc-free machine elements for rapidly bio-degradable hydraulic oils. With regard to the liquids mentioned above, the zinc-free design prevents an early "element blocking". Therefore, Rexroth filter elements can be used universally for hydraulic fluids and lubricants.

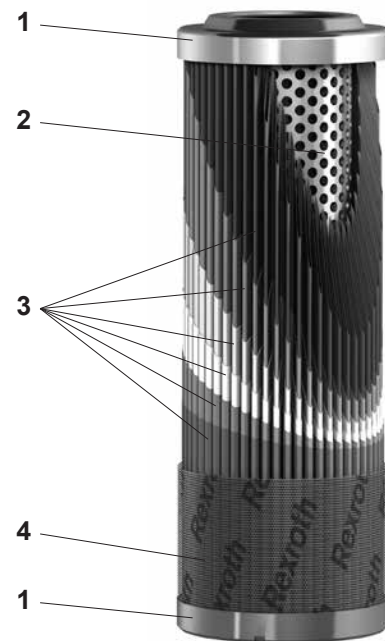

Filter variables

Filter rating and attainable oil cleanliness

The main goal when using industrial filters is not only the direct protection of machine components but to attain the required oil cleanliness. Oil cleanliness is defined on the

basis of oil cleanliness classes which classify the particle distribution of existing contamination in the operating liquid.

Filtration performance

Filtration ratio $\beta_{x(c)}$ (β value)

The retention capacity of hydraulic filters is characterized by the filtration ratio $\beta_{x(c)}$. This variable is therefore the most important performance characteristic of a hydraulic filter. It is measured in the multipass test, and is the average value of the specified initial and final pressure differential according to ISO 16889 using ISO 12103-1 test dust.

The filtration ratio $\beta_{x(c)}$ specifies the ratio of the number of particles with the same size upstream and downstream of the filter.

Dirt holding capacity

It is also measured using the multipass test and determines the amount of test dust which is fed to the filter medium until a specified pressure differential increase has been reached.

Pressure loss (also pressure differential or delta p)

The pressure loss of the filter element is the relevant characteristic value for the determination of the filter size. These are recommended values of the filter manufacturer or specifications by the filter user. This characteristic value depends on many factors. Mainly: the rating of the filter medium, its geometry and arrangement in the filter element, the filter area, the operating viscosity of the fluid and the flow. The term "delta p" is often also expressed with the symbol " Δp ".

When dimensioning the complete filter, an initial pressure loss is determined which must not be exceeded by the new filter state on the basis of the aforementioned conditions. The size design of a Rexroth filter on the basis of an initial Δp or pressure loss may be comfortably completed using our online design software "BOSCH REXROTH FILTERSELECT".

The diagram shows the typical press loss behavior of filter elements with different material fineness at different flows.

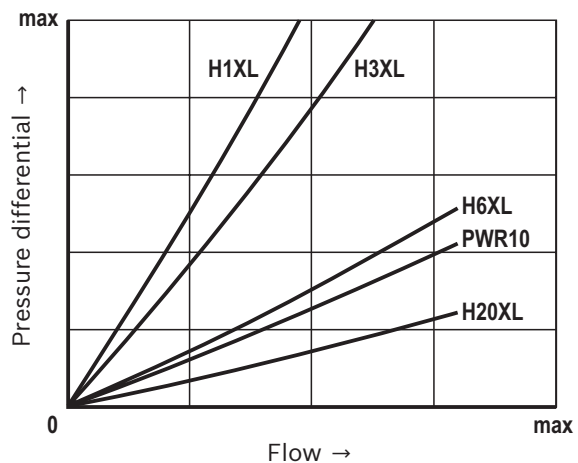
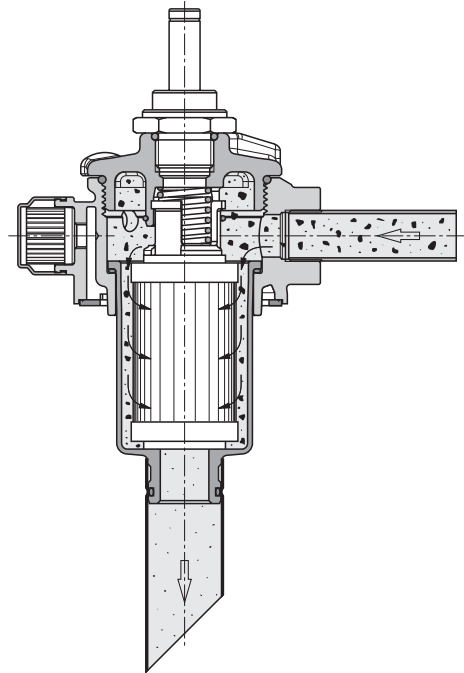

Filter media

Overview

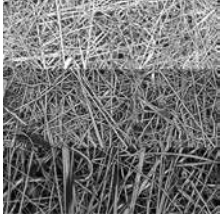
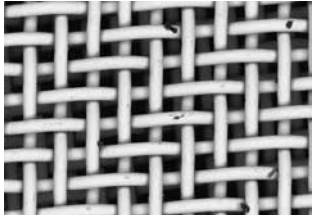
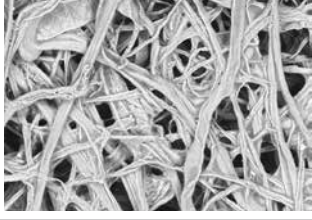
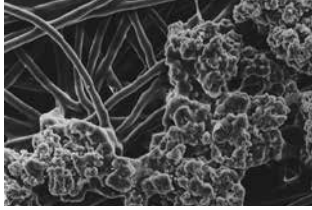
Filter medium/set-up	Electron microscope image
<p>PWR..., glass fiber material</p> <p>Glass fiber material generation 5 Configuration with a total of 6 layers consisting of 3 filter-efficient glass fiber layers, with anti-static and stainless steel mesh on the outlet side by default.</p>	
<p>G..., stainless steel wire mesh material 1.4401 or 1.4571</p> <p>Surface filter made of stainless steel wire mesh with supporting mesh.</p>	
<p>P..., filter paper</p> <p>Inexpensive depth filter made of filter paper with supporting mesh. Made of specially impregnated cellulose fiber preventing humidity and swelling.</p>	
<p>AS ..., water-absorbing</p> <p>Depth filter, non-woven material with water-absorbing material combined with micro glass filter media.</p>	

Technical data

(For applications outside these parameters, please consult us!)

general	
Filtration direction	From the outside to the inside
Ambient temperature range	°C [°F] -10 ... +65 [+14 ... +149]
Storage conditions	▶ Seal NBR °C [°F] -40 ... +65 [-40 ... +149]; max. relative air humidity 65%
	▶ Seal FKM °C [°F] -20 ... +65 [-4 ... +149]; max. relative air humidity 65%
Material	▶ Cover/base Steel, tin-coated / aluminum or polyamide (depending on the version)
	▶ Support tube Tin-coated steel
	▶ Seals NBR or FKM

hydraulic	
Minimum conductivity of the medium	pS/m 300
Reduction of the electrical charging is realized by means of a conductive non-woven medium with clearly lower resistance than previously used filter material layers. Due to its conductivity, the conductive medium in connection with a conductive supporting mesh reduces separation of charges in the various filter material layers (particularly between glass fiber and outlet layer)	

Admissible operating temperature range, depending on material combination

Material	Code letter	Operating temperature range °C [°F]
Seal		
NBR	M	-40 ... +100 [-40 ... +212]
FKM	V	-20 ... +210 [-4 ... +410]
Filter element adhesive		
Standard	0	-40 ... +100 [-40 ... +212]
Filter element material (cover, base, support tube)		
Standard	0	-40 ... +100 [-40 ... +212]
Filter element material (filter material)		
Aquasorb	AS...	0 ... +160 [32 ... +320]
Stainless steel wire mesh	G...	-55 ... +500 [-67 ... +932]
Glass fiber material	PWR...	to +160 [to +320]
Filter paper	P...	to +130 [to +266]

Compatibility with permitted hydraulic fluids

Hydraulic fluid	Classification	Suitable sealing materials	Standards	
Mineral oil	HLP	NBR	DIN 51524	
Bio-degradable	▶ Insoluble in water	HETG HEES	NBR FKM	VDMA 24568
	▶ Soluble in water	HEPG	FKM	
Flame-resistant	▶ Water-free	HFDU, HFDR	FKM	VDMA 24317
	▶ Containing water	HFAS	NBR	DIN 24320
		HFAE	NBR	
	HFC	NBR	VDMA 24317	



Important information on hydraulic fluids:

- ▶ For further information and data on the use of other hydraulic fluids, refer to data sheet 90220 or contact us!
- ▶ **Flame-resistant - containing water:** due to possible chemical reactions with materials or surface coatings of machine and system components, the service life with these hydraulic fluids may be less than expected.

Filter materials made of filter paper (cellulose) must not be used, filter elements with glass fiber material have to be used instead.

- ▶ **Bio-degradable:** If filter materials made of filter paper are used, the filter life may be shorter than expected due to material incompatibility of and swelling.

Filter media

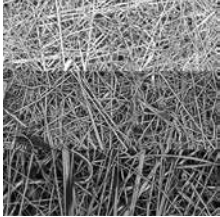
Technical data	PWR...
<p>Glass fiber material generation 5, PWR...</p> <p>The filter medium achieves the best cleanliness possible compared to other filter media. It is suitable for hydraulic oils, lubricants, chemical and industrial liquids. Due to its defined retention capacity (ISO 16889), it offers highly effective protection for machines and system components which are sensitive to contamination. An optimized dirt holding capacity in connection with an excellent cleanliness class is achieved by three glass fiber liners which are relevant for filtration. The stainless steel mesh used on the clean side is also responsible for a very high degree of stability of the filter element in case of pulsations. The electrostatic effects occurring with non-conductive fluids are reduced by the conductive non-woven medium integrated by default.</p> <ul style="list-style-type: none"> ▶ Default electrically conductive non-woven media ▶ Absolute filtration/defined retention capacity according to ISO 16889 ▶ High dirt holding capacity due to multi-layer set-up ▶ Non-reusable filter (not cleanable due to the depth filtration effect) 	
<p>Filter rating and attainable oil cleanliness</p> <p>The following table provides recommendations for the selection of a filter medium in dependency of the application and indicates the average oil cleanliness class attainable according to ISO 4406 or SAE-AS 4059.</p>	

Glass fiber material

Contamination class DIN ISO 4406	to be achieved with filter			Hydraulic system
	$\beta_{x(c)} = 200$	Material	Arrangement	
13/10/8 ... 17/13/10	3 μm	Glass fiber material	Pressure filter	----- Servo valves
15/12/10 ... 19/14/11	6 μm			----- High-response valves
17/14/10 ... 21/16/13	10 μm		Return flow or pressure filter	--- Proportional valves
19/16/12 ... 22/17/14	20 μm			- Pumps and valves in general

Attainable filtration ratio $\beta_{x(c)}$ (β value)

Typical β values of up to 2.2 bar [31.9 psi] Δp pressure increase at the filter element ¹⁾

Filter medium	Particle size "x" for different β values, measurement according to ISO 16889		
	$\beta_{x(c)} \geq 75$	$\beta_{x(c)} \geq 200$	$\beta_{x(c)} \geq 1000$
H3XL	4.0 $\mu\text{m}(c)$	< 4.5 $\mu\text{m}(c)$	5.0 $\mu\text{m}(c)$
H6XL	4.8 $\mu\text{m}(c)$	5.5 $\mu\text{m}(c)$	7.5 $\mu\text{m}(c)$
PWR10	7.5 $\mu\text{m}(c)$	8.5 $\mu\text{m}(c)$	10.5 $\mu\text{m}(c)$
H20XL	18.5 $\mu\text{m}(c)$	20.0 $\mu\text{m}(c)$	22.0 $\mu\text{m}(c)$

¹⁾ Filtration ratio $\beta_{x(c)}$ for other filter media upon request

Filtration ratio $\beta_{x(c)}$ dependent on particle size $\mu\text{m}(c)$

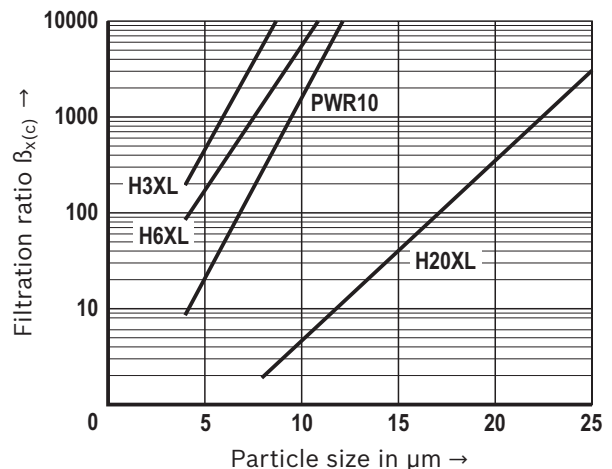

Filter media

Technical data PWR...

Dirt holding capacity according to ISO 16889
 Compared to conventional filter media with single layer technology, the PWR... filter material features a high dirt holding capacity because it is made of three separate filter layers connected in series.

Comparison of typical dirt holding capacities of glass fiber filter elements

- Conventional filter element** - - - - -
 (single-layer glass fiber material)

- Two-layer filter element** - - - - -
 (former Rexroth H...XL material combination)

- Rexroth PWR... filter element** —————
 (three-layer glass fiber material with electrically conductive non-woven medium)

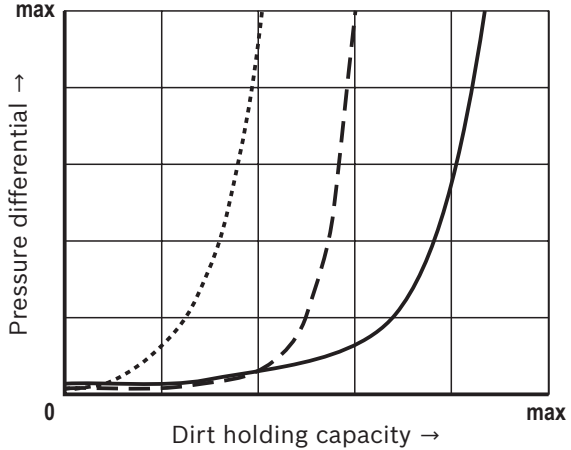

Technical data G...

Stainless steel wire mesh, G...
 There is a comprehensive field of applications for wire mesh filter media. Not only pre-filtration is possible, but also the filtration of lubricating oils, hydraulic oils, coolants and water-like fluids.

- ▶ Surface filter made of stainless steel wire mesh
- ▶ Reusable, cleanable
- ▶ Pleated design, single, two or three-layer design

Wire mesh G10 ... G40
 As surface filters, these materials are generally cleanable. Due to their fine mesh, however, cleaning is more difficult than with coarser filter mesh. Therefore, we recommend cleaning the filters in an ultrasonic bath.

Wire mesh G60 ... G100
 Due to their coarser mesh size, the cleaning of these filter media is easier.

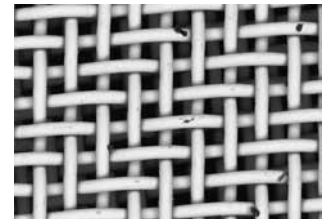

Filter medium	Design	Mesh size
G10	Special Dutch weave	10 µm nom.
G25	Woven mesh	25 µm nom.
G40	Woven mesh	40 µm nom.
G60 ... G100	Plain mesh	60 ... 100 µm nom.

Filter media

Technical data				G...
Stainless steel wire mesh				
Contamination class DIN ISO 4406	to be achieved with filter			Fluid system
	nominal	Material	Arrangement	
20/18/13 ... 21/20/15	10 µm	Stainless steel wire mesh, G...	Pressure filter	----- For existing systems (hydraulics) and as protective filter (G10, G25) For fluids such as: ► Lubricants ► Petrochemical products ► Water ► Coolants/thermal oils
Cannot be used for wire mesh > 10 µm	25 ... 100 µm		Return flow, pressure filters or suction filters	

Cleaning of filter elements

Cleaning or replacement

Before cleaning a filter element made of wire mesh, it has to be checked after dismantling of the filter element whether it makes sense to clean the element. For example, if the mesh contains many fibrous substances and consists of a material finer than G40, effective and complete cleaning is not possible in many cases. Filter mesh which has visible defects due to frequent cleaning must be replaced. In general, the following applies: The finer the mesh, the thinner the wire. Therefore, especially fine mesh must be cleaned gently to protect the material. The wire mesh must not show any cracks in the folds as otherwise, the filter capacity will be insufficient.

Cleaning frequency

Experience has shown that filter elements made of G10, G25 and G40 can be cleaned up to ten times. Filter mesh > 60 µm can usually be cleaned more than ten times. Reusability, however, very much depends on the type of contamination as well as on pressurisation (final Δp before dismantling the filter element). For maximum reusability, we therefore recommend replacing in particular the fine mesh at a final Δp of 2.2 bar [31.9 psi] at the latest. Due to the given reasons, the aforementioned values must be regarded as reference values for which we do not assume any liability.

Recommendations for cleaning

Manual and simple cleaning method for filter elements made of wire mesh

Procedure	Wire mesh G10, G25, G40	Wire mesh G60 ... G100
Chemical pre-cleaning	Let the filter element drain for approx. 1 hour after disassembly. Bathe in solvent afterwards.	
Mechanical pre-cleaning	Remove rough dirt with a brush or scrubber. Do not use hard or pointed objects which could damage the filter medium.	
Mechanical/chemical main cleaning	Put pre-cleaned element in an ultrasonic bath with special solvent. Clean the element in the ultrasonic bath until any visible contamination is removed.	Evaporate with hot washing solution (water with corrosion protection agent)
Checking	Visually check the material for damage. Replace the filter element if you identify obvious damage.	
Preservation	After drying, you must spray the cleaned element with preservative agents and store it sealed against dust in a plastic foil.	

Filter media

Technical data	G...
-----------------------	-------------

Automated cleaning for filter elements made of wire mesh

Procedure	Wire mesh G10, G25, G40, G60 ... G100
Chemical pre-cleaning	Let the filter element drain for approx. 1 hour after disassembly. Bathe in solvent afterwards.
Mechanical/chemical main cleaning	By means of special cleaning systems for filter elements. Most of these systems are provided with a fully automated and combined cleaning mechanism including ultrasound as well as mechanical and chemical cleaning processes. This allows for best possible cleaning results with gentle cleaning processes.

Technical data	P...
-----------------------	-------------

Filter paper, P...

Filter paper is used for the filtration of lubricating oil and for pre-filtration.
Filter paper has the following features:

- ▶ Depth filter made of cellulose fibers
- ▶ Specially impregnated against swelling caused by humidity
- ▶ Pleated design, single, two or three-layer design
- ▶ Non-reusable filter (not cleanable due to the depth filtration effect)

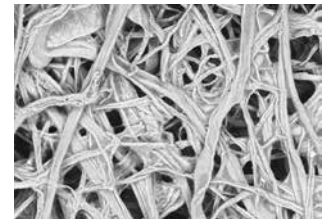

Filter medium	Nominal filter rating in μm	Filtration ratio β values ¹⁾	Retention rate with 10 μm ¹⁾
P10	10	$\beta_{10(c)} > 2.0$	50 %
P25	20	$\beta_{10(c)} > 1.25$	20 %

¹⁾ according to ISO 16889

Filter paper

Contamination class DIN ISO 4406	to be achieved with filter			Hydraulic system
	$\beta_{x(c)} = 200$	Material	Arrangement	
20/19/14 ... 22/20/15	10 μm	Paper P...	Return flow or pressure filter	----- For existing systems
21/20/15 ... 22/21/16	25 μm			

Installation, commissioning and maintenance

When has the filter element to be replaced or cleaned?

As soon as the dynamic pressure or the pressure differential set at the maintenance indicator is reached, a signal is output. If an electronic switching element is provided, an electric signal will sound. In this case, the filter element must be replaced or cleaned.

Filter elements should be replaced or cleaned after max. 6 months.

Notice:

If the maintenance indicator is disregarded, the disproportionally increasing pressure differential may damage the filter element (collapse).

Filter element exchange

Detailed instructions with regard to the filter element exchange can be found on the data sheet of the relevant filter series.

WARNING!

- ▶ Filters are containers under pressure. Before opening the filter housing, check whether the system pressure in the filter has been decreased to ambient pressure. Only then may the filter housing be opened for maintenance.
- ▶ Warranty becomes void if the delivered item is changed by the ordering party or third parties or improperly mounted, installed, maintained, repaired, used or exposed to environmental conditions that do not comply with the installation conditions.

Directives and standardization

Rexroth filter elements are tested and quality-monitored according to various ISO test standards:

Filtration performance test (multipass test)	ISO 16889:2008-06
Δp (pressure loss) characteristic curves	ISO 3968:2001-12
Compatibility with hydraulic fluid	ISO 2943:1998-11
Collapse pressure test	ISO 2941:2009-04

The development, manufacture and assembly of Rexroth industrial filters and Rexroth filter elements is carried out within the framework of a certified quality management system in accordance with ISO 9001:2000.

Environment and recycling

- ▶ The used filter element has to be disposed of according to the country-specific legal regulations for environmental protection.
- ▶ After the service life of the filter, the filter components can be recycled according to the applicable country-specific legal regulations for environmental protection.

Bosch Rexroth AG
Hydraulics
Zum Eisengießer 1
97816 Lohr am Main, Germany
Phone +49 (0) 93 52/18-0
documentation@boschrexroth.de
www.boschrexroth.de

© This document, as well as the data, specifications and other information set forth in it, are the exclusive property of Bosch Rexroth AG. It may not be reproduced or given to third parties without its consent.
The data specified above only serve to describe the product. No statements concerning a certain condition or suitability for a certain application can be derived from our information. The information given does not release the user from the obligation of own judgment and verification. It must be remembered that our products are subject to a natural process of wear and aging.