



MUI

MC235.09

Position control with self-learning

User manual and installation

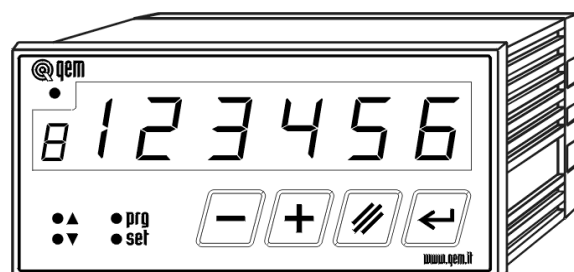

1. Information	1
2. Description	6
3. Installation	9
4. Electric Properties	10
5. Wiring	12
6. Functioning	18
7. Parameters entering	20
8. Use	24
9. Assistance	30

1. Informations	4
1.1 Symbols.....	4
1.2 Limited Warranty.....	4
1.3 Reference Manuals.....	4
1.4 Validity.....	5
1.5 Norm references.....	5
2. Description	6
2.1 Product code.....	6
2.2 Technical characteristics.....	7
2.3 Mechanical dimensions.....	8
3. Installation	9
4. Electric properties	10
4.1 Power supply.....	10
4.2 I1 / I2: Digitals inputs.....	10
4.3 PH A /PH B: Bidirectional encoder phases.....	11
4.4 U1/U2/U3/U4: digital outputs (expansion card U04).....	11
5. Wiring	12
5.1 Connection description.....	12
5.2 U04: expansion card.....	13
5.3 Wirings examples.....	14
5.4 Wiring examples.....	15
6. Functioning	18
6.1 Release message.....	18
6.2 Keyboard functions.....	18
6.3 Using graphic.....	19
6.4 "Data out of range" visualization	19
7. Parameters entering	20
7.1 Programming (Set-up).....	20
7.2 Calculation of the encoder resolution.....	21
7.3 Errors caused by not ended resolutions.....	22
7.4 Relative/absolute counter(C = 1*)	22
7.5 Preset of the Count	22
7.6 With the parameter AI = 1*.....	23
7.7 With the parameter C = 2*	23
7.8 Max and Min Quota Self-Learning.....	23
8. Use	24
8.1 Working programs and auxiliary functions.....	24
8.2 Functioning tables and graphis.....	25
8.3 Using examples.....	29

9.1	Request of assistance.....	30
9.2	Shipment.....	30

1. Informations

Thanks for buying this QEM instruments. We'll be glad to receive any suggestion at our e-mail address info@gem.it.

1.1 Symbols



Not reading the message will be dangerous for the instruments integrity and/or for the success of the operation.



Note: Important information for the correct use of the instruments.



For more informations see the user manual indicated in the message.



For more informations see the indicated pages.

1.2 Limited Warranty

For two years from the original acquisition, QEM will repair or replace for free controls and devices that QEM thinks be imperfect in materials or quality. This warranty is not valid if the object has been tampered by not authorized persons or used in an inappropriate way.

This warranty replaces all other warranties either expressed or implicit.

QEM doesn't hold personally responsible for all charges (installation or uninstalling included), draw-back, or damage caused by our products, made or sold. In any case, QEM total duty, always will not exceed the control total price.



Claims for refunds of selling price, reparations, or replacements must be referred to QEM with all pertinent data (damage, purchase date, developed work and problem).

It is not provided any duty for batteries and fusible cut-out consumption.

The product must be returned only with a written notification, included the Number of Restitution Authorization QEM and must be paid all forwarding charges.

1.3 Reference Manuals

The documentation referred to the QEM instrumentation in divided in many issues that allows an easy utilization.

	MUI: User and installation manual Instrument hardware and software informations.
	MIMAT: Maintenance, service and installation manual. Informations on: wiring, right calibration, parameters insertion and breakdown individuation.

It is possible to download manuals from www.gem.it

1.4 Validity

M: manual
S: instrument

The present document is fully valid excepted mistakes or omissions.

Release	Description	Date
1	M New manual.	15/12/2005
	M Data corrections.	22/12/2005
	M Content review.	31/10/2006
	M English version.	10/11/2006
	M New measure	13/04/2007
	M Insert new code	03/10/2007
	M Insert CX9 model	15/12/2010
	M Input's type note	25/07/2011
	M Change outputs voltage value from 110V to 24V	12/01/2015
	M New function 3 on the $R I$ parameter	07/10/2015

Editor:  Product Manager: 

Approved by Technical manager: 

Trade Marks

The copyright of this user manual is reserved. No one part of this document can be reproduced or copy without the QEM appointment. QEM doesn't present insurances or warranties on contents and declines all responsibilities on identity warranties. In this document, informations can be modified without any notice. QEM doesn't have any responsibility on this document.

Trade Marks:

- QEM® is a trade mark.

1.5 Norm references

European norm includes some rules and recommendations about control security systems with elements of operator interface.

<i>Protection rate</i>	IP20 (Conform on EN 60-5-29)
<i>Frontal protection rate for container (optional)</i>	IP54
<i>IP65 frontal protection rate with packing for container(optional)</i>	IP65
<i>Vibration resistance</i>	Conform on IEC 68-2-6
<i>Bump resistance</i>	Conform on IEC 68-2-27
<i>Jamming immunity</i>	Conform on EN 50082-2
<i>Emission level</i>	Conform on EN 50081-2
<i>Container</i>	DIN43700

2. Description

MC235.09 is a quotas and axis position visualizator, has 4 programmable outputs (for quotas and also in the intervention logic) that can allows to use the instrument also as measurer and position controller respect to the set measures ore self-learned.

This instrument substitutes obsolete products like HB235.09A

General Characteristics

- 2 digital inputs
- 4 digital programmable outputs;
- 1 counter input;
- Preset quota loading;
- Self-learned quotas;
- Single cycle functioning / continuous;
- Polarized terminals.

Options

- Personalized panel;
- Dedicated power supply voltage;
- Superior encoder counter frequencies;
- Specialization on customer specifications..

2.1 Product code

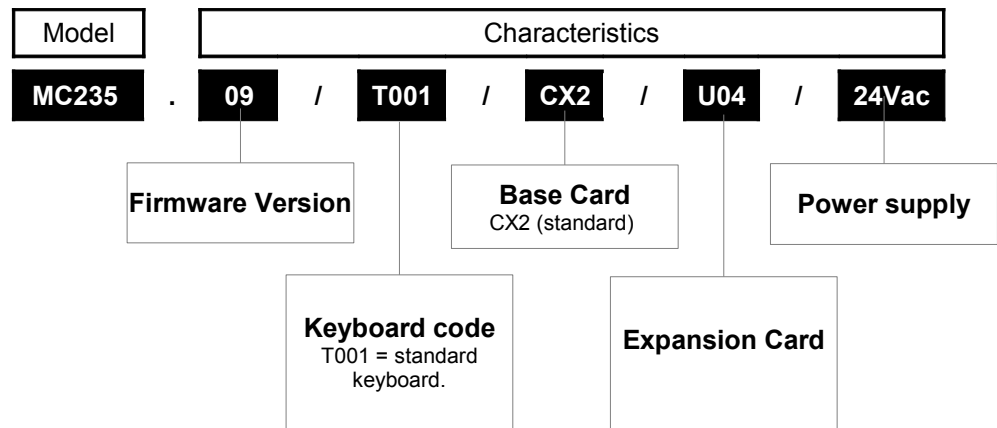

CX_ : Basic Card

		CX1	CX2	CX3	CX4	CX5	CX6	CX7	CX8	CX9	CXA	CXB
PHA / PHB: Encoder phases	<i>Frequency</i>	15 KHz		200 KHz					15KHz	50 KHz		
	<i>Encoder type</i>	PP				LD				PP	PP	
	<i>Voltage level of encoder phases</i>	12 / 24 V				2 / 3,5 V				5V	12 / 24 V	
I1 / I2 *: Digital inputs	<i>Frequency</i>	10 KHz						100 KHz	10KHz	10 KHz		
	<i>Polarization</i>	PNP	NPN	PNP	NPN	PNP	NPN			PNP	NPN	
	<i>Inputs voltage level</i>	10,5 / 26,5 V						5 V		10,5 / 26,5 V		
Vout ext	<i>Delivered power supply</i>	12 V						5 V		12 V		

* Activation time depending from the R I parameter (\overline{I} , I and $\overline{I} = 50\text{ms}$; $\overline{I} = 2\text{ms}$)

2.1.1 Accessories



Measured in mm.

Description	Code
Container frontal protection (IP54)	23040001
Packing frontal protection for container (IP65)	23040044

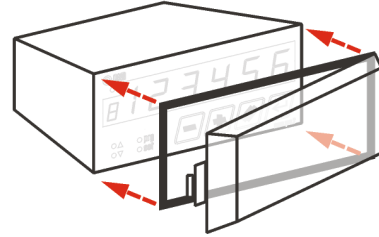
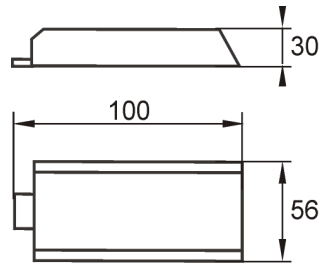

2.2 Technical characteristics

weight (max. hardware composition)	450 gr
Container material	Plastic noryl UL 94 V-O
Display	1 display h = 8 6 display h = 14
Buttons	4 mechanical buttons with tactile feeling
Led	5
Working temperature	0 / 50 °C
Relative humidity	90% without condensation
Altitude	0 / 2000 m
Atmosphere	Not corrosive gasses
Transport and stocking temperature	-25 / +70 °C

2.3 Mechanical dimensions



Measured in mm.



Mechanical installation pag. 9

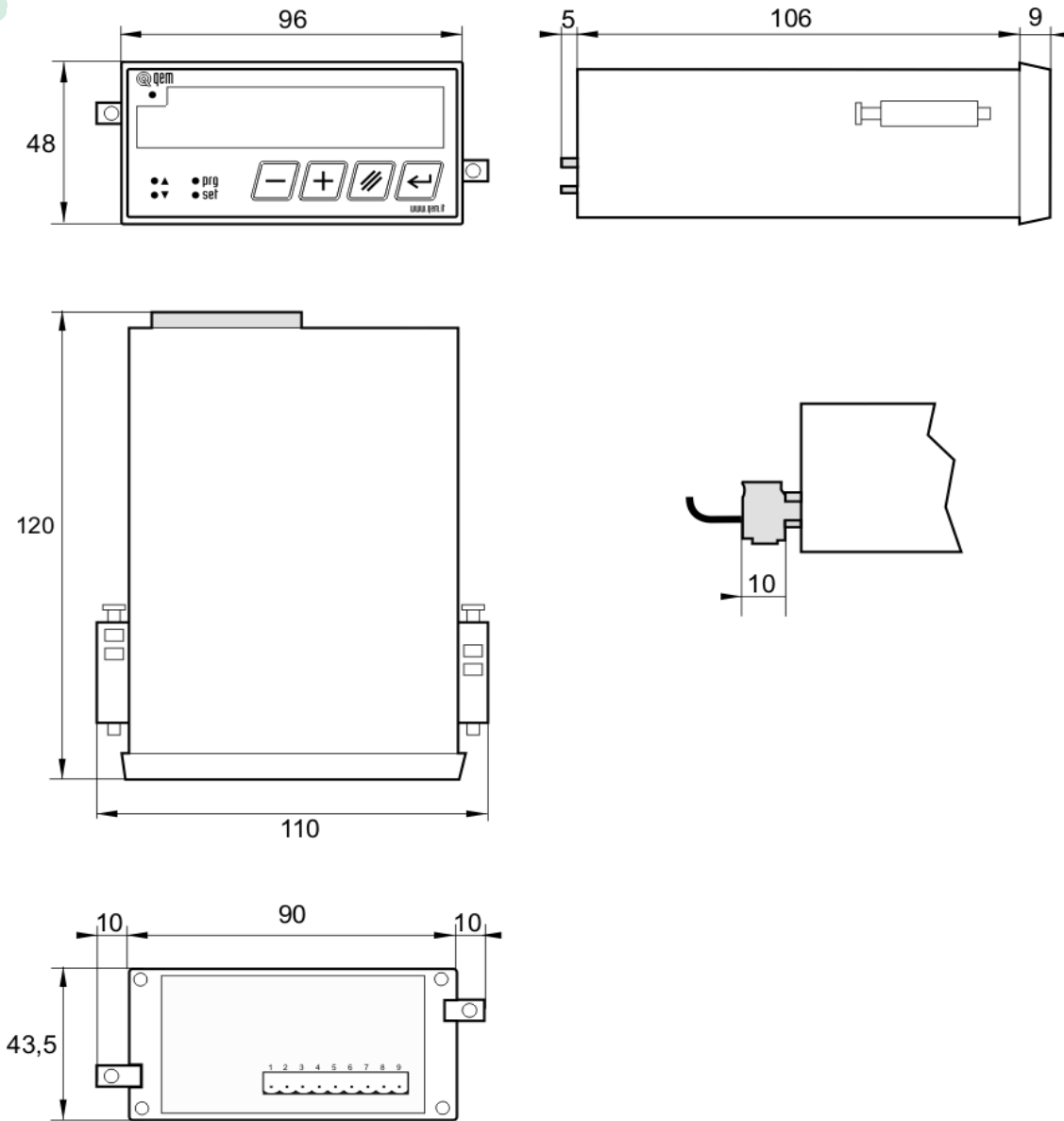

Fig. 1 Back view

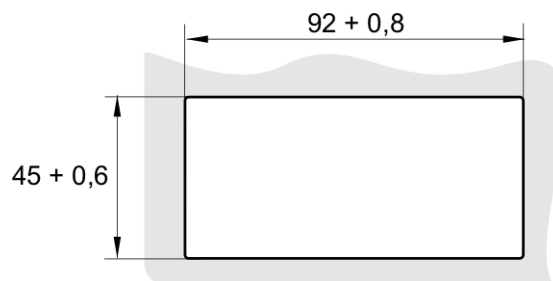
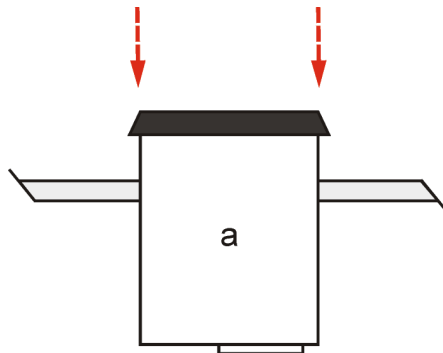

Fig. 2 Perforation area

3. Installation

 For a correct installation read **MIMAT** manual



a) Insert the instrument in the hole;

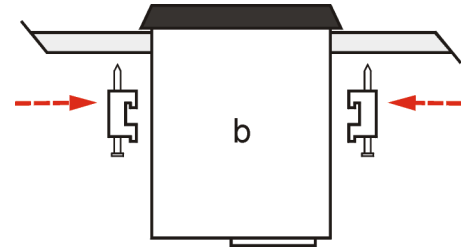

b) Apply hooks;

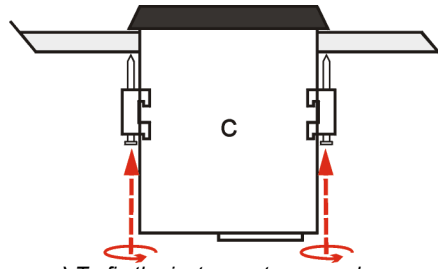

c) To fix the instruments screw down.

4. Electric properties

4.1 Power supply

• = Variable data. See the model **Basic Card CX**

	Vac	Vdc
Available power supply	24 / 27 / 110 / 230 Vac	24 Vdc
Range val	-15 / +10%	18 / 30 V
Frequency	50 / 60 Hz	dc
Absorption max.	8 VA	
Volt ext.*	12 Vdc - 100mA	

4.2 I1 / I2: Digitals inputs

• = Variable data. See the model **Basic Card CX**

		CX 1	CX 2 (standard)
Polarization *		PNP	NPN
Frequency *		10 KHz	
Optoinsulation		1500 V rms	
Nominal operating voltage		12 / 24 Vdc	
Logic state 0 Voltage		< 3 V	
Logic state 1 Voltage		> 8 V	
Input resistance		1,5 KΩ	
Internal voltage drop (see Fig.3)		1,2 V	
Lowest acquisition time I1	Activation C	50 ms	
	Activation I	10 μsec.	
Lowest acquisition I2		50 ms	

C: continuous
I: impulsive

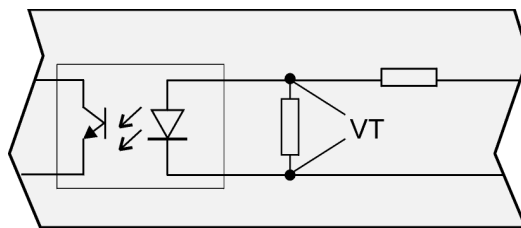

Fig. 3 Internal voltage drop

N.B.: For the other inputs' features, please contact QEM's sales office

4.3 PH A /PH B: Bidirectional encoder phases

* = Variable data. See the model Basic Card CX_

	Encoder 12 V		Encoder 24 V
	CX 1	CX 2 (standard)	
<i>Polarization *</i>	PNP	NPN / Push - Pull	
<i>Frequency *</i>	20 Khz		
<i>Optoinsulation</i>	1500 Vrms		
<i>Logic state 0 Voltage</i>	< 3 Volt		
<i>Logic state 1 Voltage</i>	> 8 Volt		
<i>Input resistance</i>	1,5 K Ω		
<i>Internal voltage drop</i>	1,2 Volt		

N.B.: For the other inputs' features, please contact QEM's sales office.

4.4 U1/U2/U3/U4: digital outputs (expansion card U04)

<i>Commutable load</i>	AC – DC (NPN/PNP)
<i>Optoinsulation</i>	1500 Vrms
<i>Functioning Voltage</i>	24 Vac/Vdc
<i>Maximum current</i>	70 mA
<i>Dispersion current</i>	20 μ A
<i>Internal voltage falling</i>	2,5 V
<i>Commutation time from ON to OFF</i>	120 μ s
<i>Commutation time from OFF to ON</i>	8 μ s

5. Wiring

5.1 Connection description

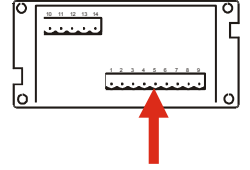

* = Variable data. See the model **Basic Card CX**

 For more information on I1 input programming, see **Function I1 input in Program (set-up)** at pag 21

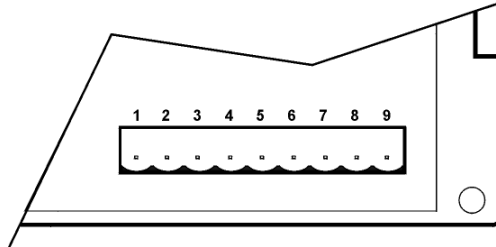
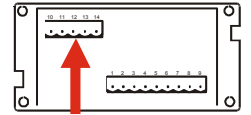

Fig. 4 Back connector

Terminal	Name	Logic activation state	Way of activation	Description
1	12 V *	-		Volt ext.
2	0 V			
3	I1	On	C / I	Digital input I1 / Phase Zero encoder. Programmable.
4	I2	On	C	Digital input I2. Zero setting counter, or charging permission.
5	PH A	On	I	Bidirectional encoder phases.
6	PH B			
7	Vac / - Vdc	-		Power supply voltage.
8	Vac / + Vdc			
9	GND	-		Ground connection. Connect a conductor with 2mm ² section to the PE bar.

C: continuous
I: impulsive

5.2 U04: expansion card



for more information for the programming, please see at the chapter Programming (**Set-up**) at pag. 20



For more information see the chapter Use at pag. 24

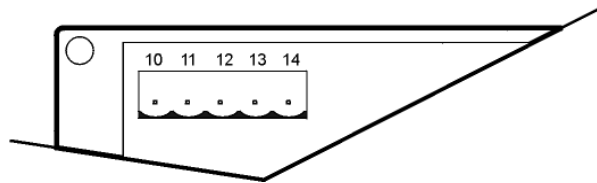

Fig. 5 Expansion terminal U04

Terminal	Name	Logic activation state	Way of activation	Description
10	COM	ON	-	Common digital outputs (U1÷U4)
11	U1	ON	C	Min Quota. Programmable by "E" parameter.
12	U2	ON	C	Min slow-down. It reduces the axis speed near the arrival point.. Programmable by "E" parameter.
13	U3	ON	C	Max Slow-down. It reduces the axis speed near the arrival point. Programmable by "E" parameter.
14	U4	ON	P	Max quota. Programmable by "E" parameter.

Legend

C: continuous

P= Programmable

5.3 Wirings examples



For a correct installation see **MIMAT** manual.

5.3.1 Power supply connections

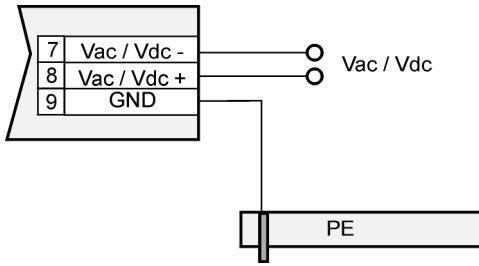

5.3.1.1 Notes

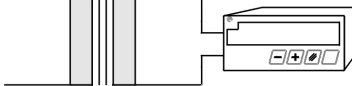

Fig. 6 Use a transformer 50VA min. sec. 24 Volt

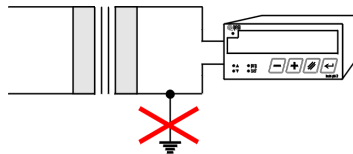

Fig. 7 Don't connect power supply voltage to the ground

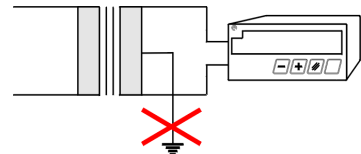

Fig. 8 Don't connect the transformer central terminal to the ground

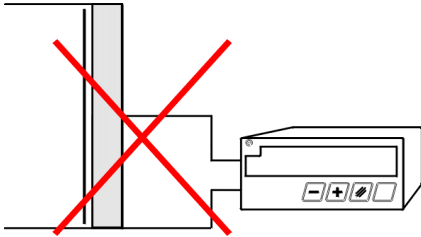

Fig. 9 Don't use auto transformer

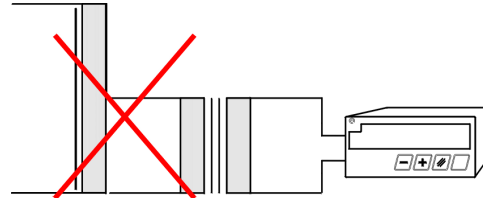

Fig. 10 Don't use transformer headed by an auto-transformer

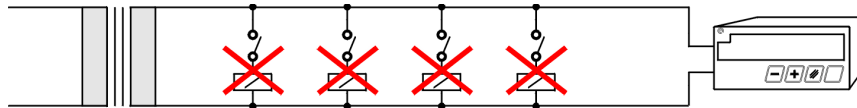





Fig. 11 Don't set coils, electro-valve etc. in parallel

5.4 Wiring examples

 The wiring examples change according to Basic Card CX characteristics installed in the instrument. (pag. Errore: sorgente del riferimento non trovata)

 For other wiring example read **MIMAT** manual.

 Possible only with Basic Card CX2.

5.4.1 Basic card CX2 (Standard)

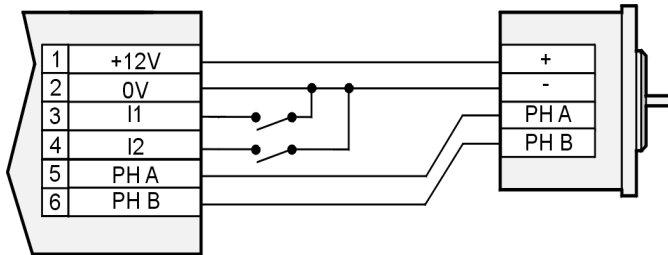

Fig. 12 Digital input polarization NPN.
Bidirectional encoder phases connection NPN / Push Pull.

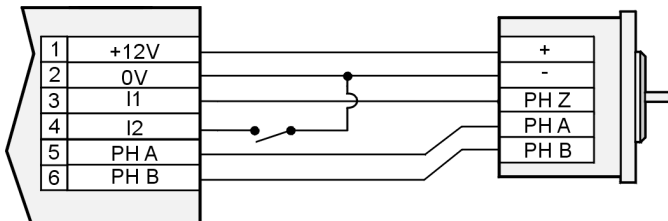

Fig. 13 Digital input polarization NPN.
Bidirectional encoder phases connection NPN / Push Pull with I1 Impulsive.

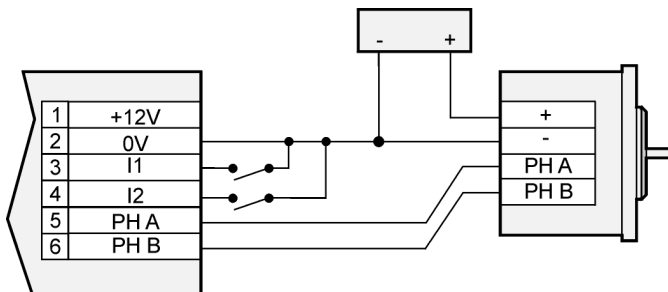

Fig. 14 Digital input polarization NPN.
Bidirectional encoder phases connection NPN / Push Pull fed externally

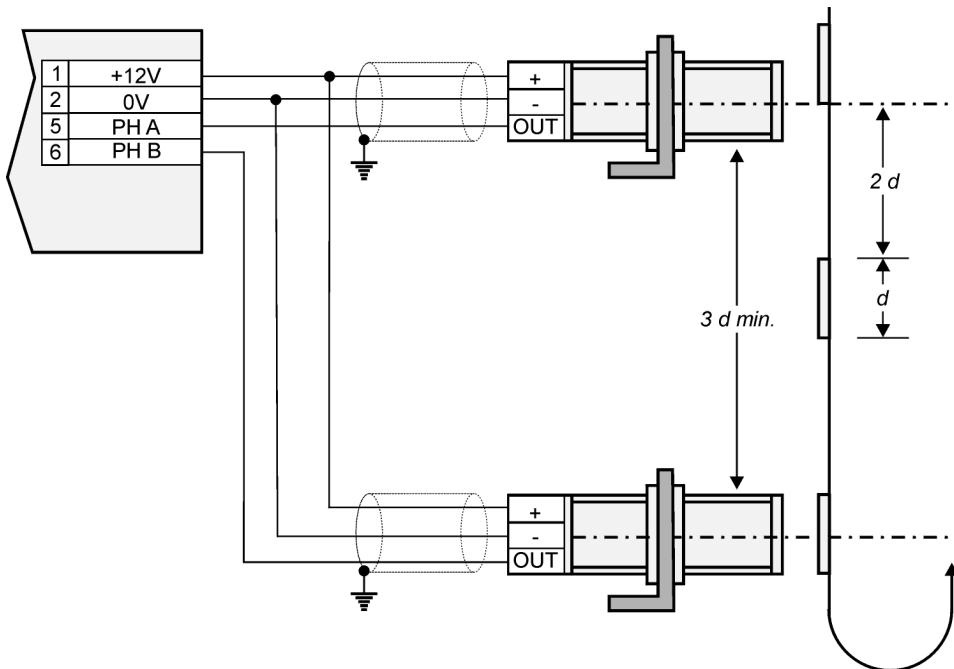

Fig. 15 Bidirectional encoder phases connection NPN / Push Pull with 2 proximity like encoder.

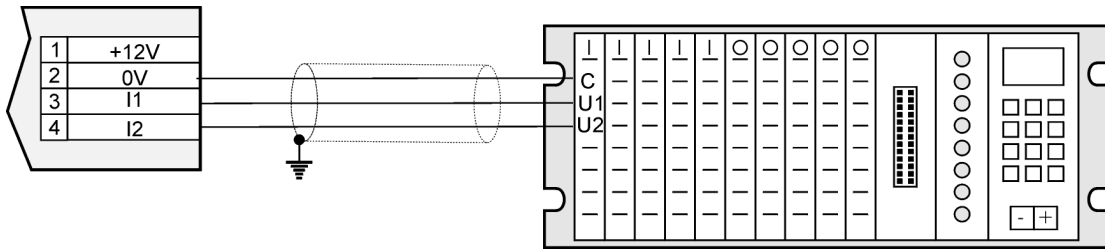

Fig. 16 Digital inputs NPN connected to a PLC fed by a MC235.09.

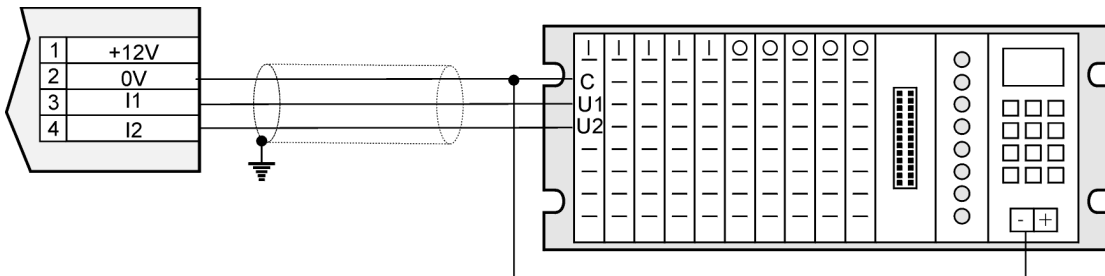

Fig. 17 Digital inputs NPN connected and fed (Vdc) by a PLCI

5.4.2 Basic Card CX1

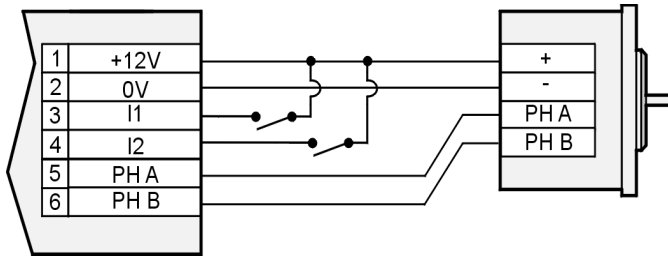

Fig. 18 Digital input polarization PNP.
Bidirectional encoder phases connection PNP

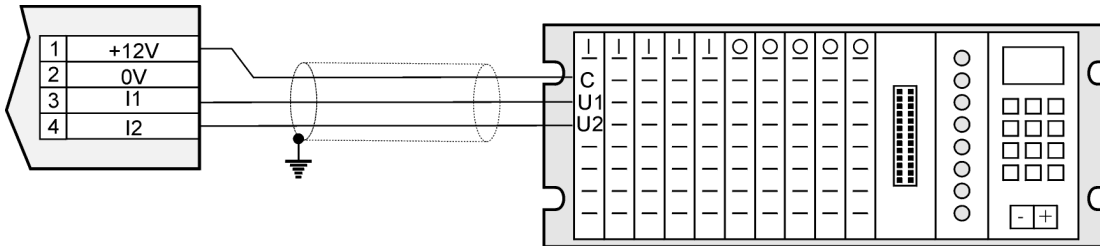

Fig. 19 Digital inputs PNP connected to a PLC and fed by a MC235.09.

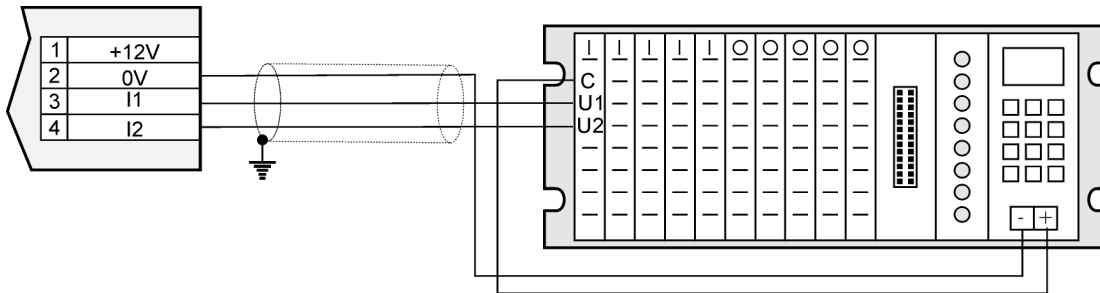

Fig. 20 Digital inputs PNP connected and fed (Vdc) by a PLC

5.4.3 Expansion card U04

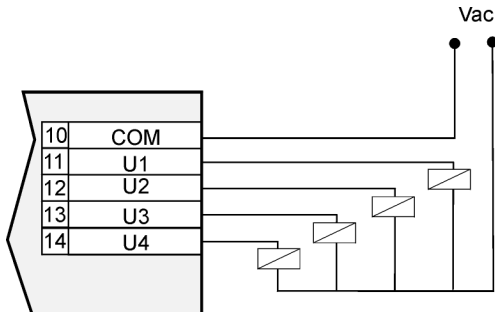
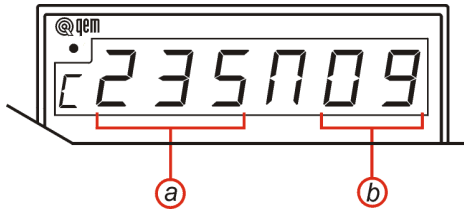

Fig. 21 Output expansion (U04)

6. Functioning

6.1 Release message

At the turning on the display shows:



1°: a) Instrument family;
b) Instrument firmware version.

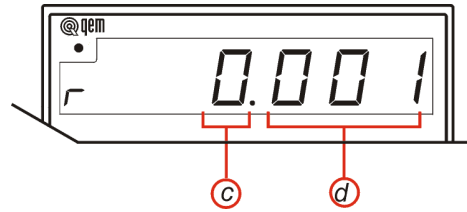

2°: c) Release;
b) Granting.

6.2 Keyboard functions

Some buttons functioning depends by the **Programming (Set-up)** pag. 20.

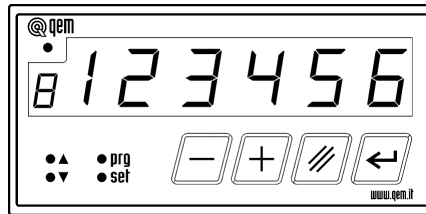
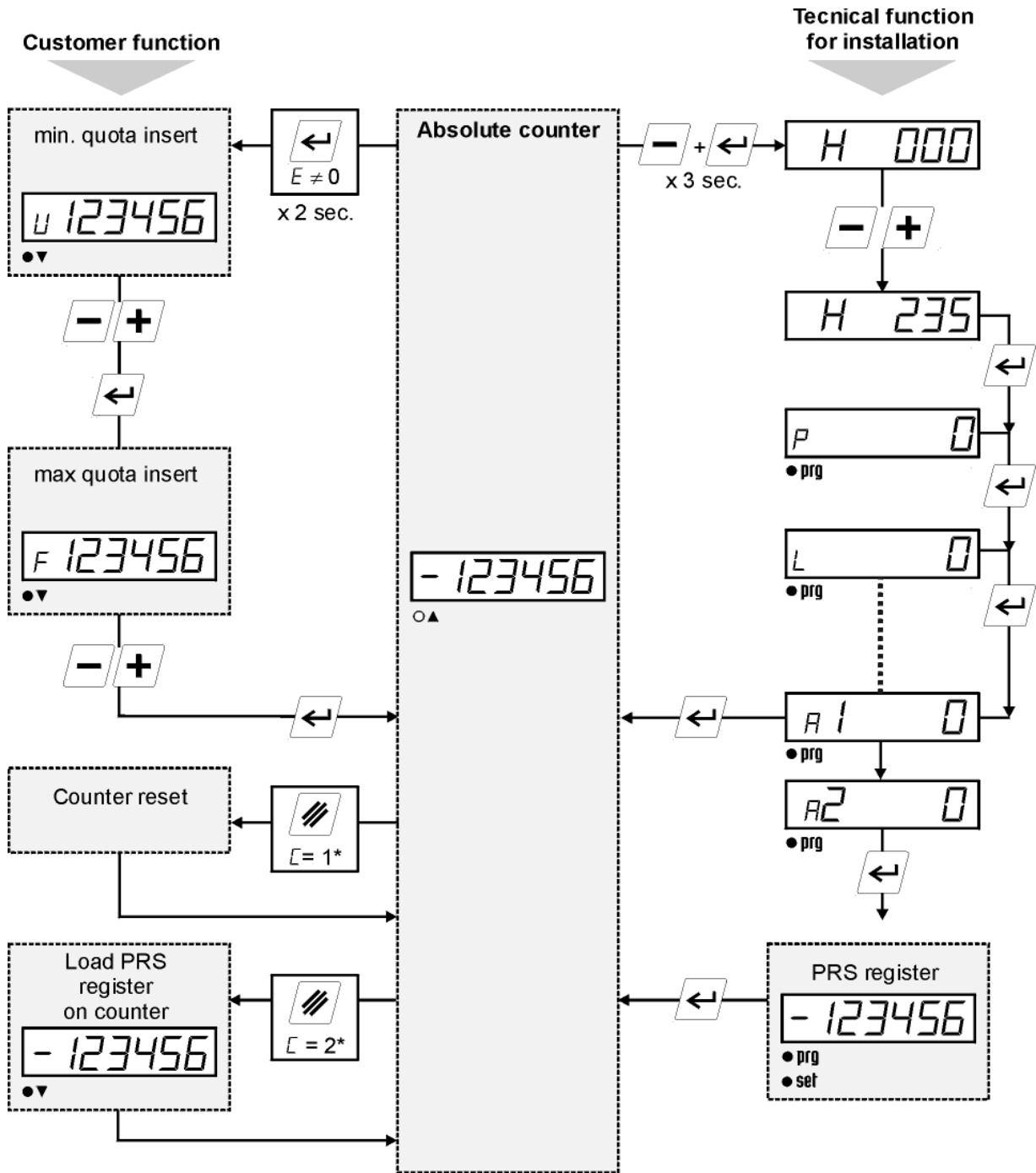

Fig. 22 Keyboard

 Enter	<p>Data insertions: It confirms the data introduction. Normal functioning: pushing the button enter the quota min and max programming.</p>
 Clear	<p>Data insertions: Cancel the inserted value, giving the past value. Normal working: If $\bar{L} = 1$ counter reset; If $\bar{L} = 2$, allows / not allows relative counter.</p>
 +	<p>It increases the selected number.</p>
 -	<p>It selects the number with a shift from left to right.</p>
 ● prg	<p>Led. ON = gives the parameters introduction state (set-up).</p>
 ● set	<p>Led. ON = informs the access to the storage register "PRS".</p>
 ● ▲	<p>-</p>
 ● ▼	<p>Led. Switched on during the min and max quota insertion.</p>
 a) ● b) □	<p>a) Led. Lighting after a self-learning. b) Display (first display from left) gives a differentiation of visualized data. If $\bar{R} = 1$ informs negative counter.</p>
 ← + -	<p>Access to password protected functions</p>

6.3 Using graphic



* = **Programmation (Set-up) parameter pag. 20**

++

○ Led = Off.
● Led = On.

6.4 “Data out of range” visualization

If introduced data are out of range, the display visualizes:

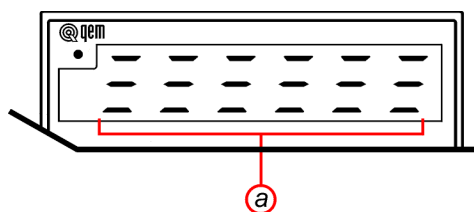

















a) Data out of range







7. Parameters entering

7.1 Programming (Set-up)

Parameters define the instrument functioning way, their access is reserved for a technical installation with a password.

Description	Keyboard	Visualization
For entering in the Programming (Set-up).	 +  x 3 sec.	
Introduce the access code "235" and confirm with enter.	  	





Function	Display	Description
decimals Max. 3		It specifies the number of decimals for the counter visualization (axis position).  The introduction of decimals influences on the VISUALIZATION; the precision depends on the number of impulses provided by the encoder.
Encoder resolution		ENCODER ROTATION-IMPULSES MULTIPLICATOR to allow different unit of measure. <i>Range: 0.00200 / 4.00000</i>  For more info please see the MIMAT manual .
CLEAR		0 = blocked functioning; 1 = Set to zero the counter; 2 = Load the memory register PRS on the counter.
Way of functioning		0 = Blocks for the data insertion (CLEAR remains activated). It is possible the self learning by I1 and I2 inputs if enabled. Pushing ENTER it is possible to read the min and max quota. 1 = Keyboard enabled . Remains the self-learning. 2 = Double pre-selection . The min quota becomes an intermediate pre-selection with slow-down between zero and max quota (with self-learning). 3 = Block counter . Similar to <i>Double pre-selection</i> but reached the max quota the counter is blocked and the U4 output remains excited up to the next reset (without self-learning). 4 = Automatic Cycle . Similar to <i>Double pre-selection</i> but reached the max, at the end of the set time, the value of the max quota will be subtracted from the count and the U4 output remains excited for the the set time(without self-learning). 5 = Single pre-selection . It is enabled only the max quota. His functioning is similar to the automatic cycle (without self-learning).  See tables at pag. 25
Timer 0,001 ÷ 9,999		Timer that starts when the U4 output is excited and it determinates the excitation time.
Min Slow-down Max. 9999		Tell the distance from the positioning quota, where the axis has to slow-down to facilitate the stop. Where the speed changes is the result of: <i>Positioning quota – Min slow-down</i> . The introduction of too small values can change the precision in the in the positioning.

Function	Display	Description
Max slow-down Max. 9999		Tell the distance form the positioning quota, where the axis has to slow-down to facilitate the stop. Where the speed changes is the result of: <i>Positioning quota – Min slow-down</i> . The introduction of too small values can change the precision in the in the positioning..
Input I2 functioning		<p>0 = Continuous loading of the memory register PRS on the counter. 1 = Impulsive loading of the memory register PRS on the counter. 2 = Min quota self-learning. 3 = Similar of the <i>I</i> mode but the minimum activation time is 2ms instead of 50ms.</p> <p> With the $\bar{L} = 2$ parameter, the <i>A I</i> parameter is forced to 2.</p> <p> With $E = 3,4,5$ the <i>A I</i> parameter cannot be "2".</p>
Input I1		<p>0 =Min quota self-learning. 1 =Max quota self-learning. 2 =Disabled input.</p> <p> With $E = 3,4,5$ the <i>A2</i> parameter is 2.</p>
Memory register PRS		Loaded quota on the counter at the activation of the I2 input, if the $A I \neq 2$ or pushing the CLEAR button if $\bar{L} = 2$.
Ended the programming of the last function, returns the first visualization, before entering in the set-up.		

7.2 Calculation of the encoder resolution

In "Encoder resolution" (\bar{L}) parameter is the number of unite measure that we want visualize in the number of impulses generated for an encoder phase.

Example:

Space in measure unit	Encoder Impulses	Encoder resolution	P	Visualization (conversion of impulses)
S	I	$\bar{L} = S / I$		
500	2000	0,25000	0	
500	2000	0,25000	1	
7423	4096	1,81226	1	
5000	2000	2,50000	2	

7.3 Errors caused by not ended resolutions

In the “Encoder resolution” (L) parameter, at page 20, it is possible to specify the value of the coefficient to convert impulses in measure unit with a precision up to 5 decimals.

If the coefficient has a number of decimals bigger of five it is needed an insertion of an approximate value. In this way an imprecision occurs.

See an example for this kind of imprecision and when can give problems.

If the space in 0.1 mm is :	S = 7423
And to this space correspond a number of impulses:	I = 4096
The theoretic resolution is:	L = 1.812255859...
That has to be approximated to the value:	L = 1.81226

In this way every 4096 impulses we have an imprecision of 5×10^{-6} decim of mm.

The results is that after:	$4096 / (5 \times 10^{-6}) = 8192 \times 10^9$ impulses
----------------------------	---

The visualization of the measure is not correct, is failed of a decim of millimetres.

The user has to decide if for his application this imprecision is tolerable.

It is possible that:

- The number of impulses to commit an error of a decim of millimeter is very big and in the application it'll never be reached without a counter reset, so there are no problems.
- The number of impulses can be reached, but the imprecision a decim of millimeter is irrilevant in the application, so there are no problems.
- The max number of impulses reached during the application, without having a counter reset, is many times more than the calculated value.

So the error is also bigger than a decim of millimeter , that it is not acceptable. In this case we suggest to do mechanical modifications or to the number of impulses of the transducer to allow a resolution ended in max 5 decimals.

7.4 Relative/absolute counter($L = 1^*$)

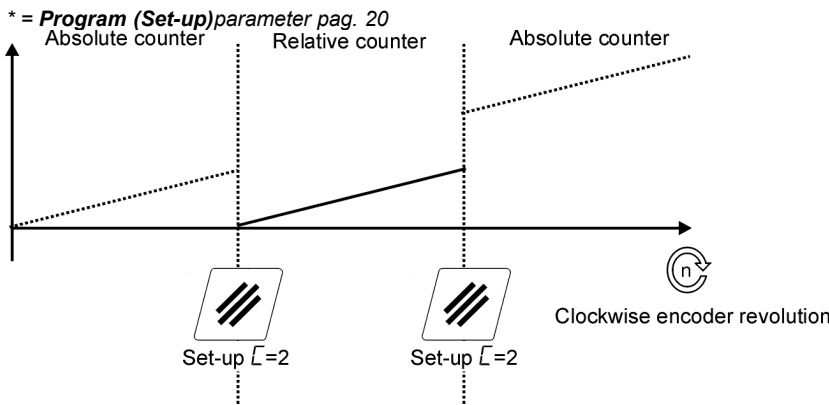

7.5 Preset of the Count

 for more information , please see at the chapter Programming (Using graphic) at pag. 19

* = Parameter of Set-up pag. 20

The encoder can be moved without the instrument power-supply lit is necessary that at every power on an instrument re-calibration with a physic measure in the axis; this function, generally named “Preset”, can be obtained using incremental transducers with “zero impulse” or with limit switches.

7.5.1 With the parameter $R I = 0^*$

Activating the I2 digital input, it transfers the value of the PRS register to the count.

The count is blocked to the PRS value until the inputs remains enabled.

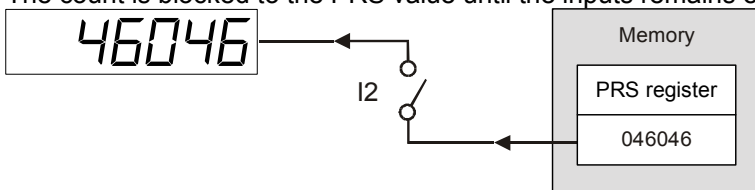

7.6 With the parameter AI = 1*

The activation of the digital input I2 transfers the value from the PRS register to the count. The count is not blocked.

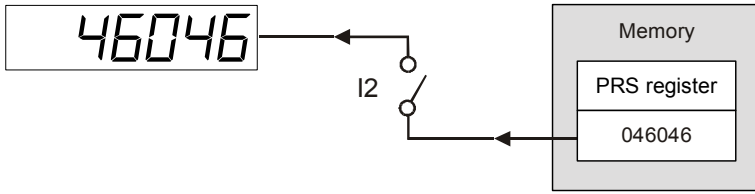

7.7 With the parameter C = 2*

Pushing CLEAR the value of the PRS value is transferred in the count.

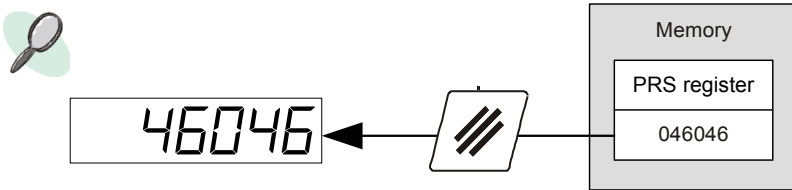

7.8 Max and Min Quota Self-Learning

The instrument doesn't self-learn the min quota if bigger than the max and contrary. With the parameter $\bar{E} = 3,4,5$ the self-learning is disabled.

7.8.1 Minimum quota self-learning

$R1 = 2$

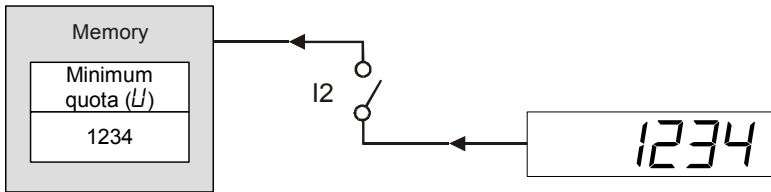

I2 has to be enabled at least for 50 milliseconds.

$R2 = 0$

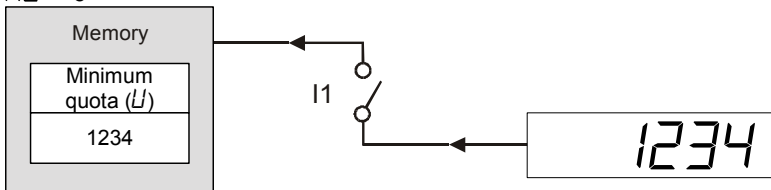

I1 has to be enabled at least for 30 milliseconds.

7.8.2 Maximum quota self-learning

$R2 = 1$

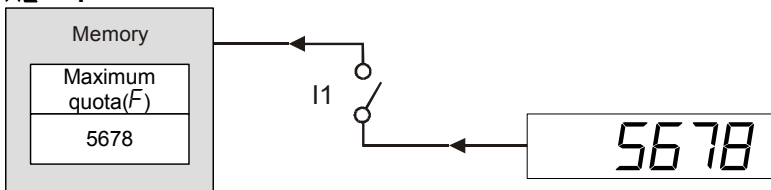











I1 has to be enabled at least for 30 milliseconds.

8. Use

8.1 Working programs and auxiliary functions

8.1.1 Max and Min quota inserting

Description	Buttons	Display
Enter to insertion of max and min quotas.	 X 2 sec.	
Is visualized the min quota in use (lighting). The operator can insert the desired quota and confirm it with ENTER .		●▼ = on
It is required the inserting of the max quota.	  	
The operator can insert the desired quota and confirm it with ENTER . The display returns on the count visualization.		
 If in set-up "E" = 5 the display visualizes only the max quota.	  	●▼ = on ●▼ = off

8.1.2 Visualizations

The instrument visualizes also the negative quotas, but the intermediate ones, max and preset can be only positive.

 During the automatic zero setting the parameter timer (τ) has to be smaller than the time necessary to the machine reach the pre-selection.

Example.

Count Frequency = 300 impulses / sec
 Quota = 450 impulses
 Timer (τ) = 2 seconds (wrong)
 the timer has to be smaller than 1.5 seconds for not cause malfunctions.

8.2 Functioning tables and graphis

8.2.1 With parameter "E" = 0 or 1

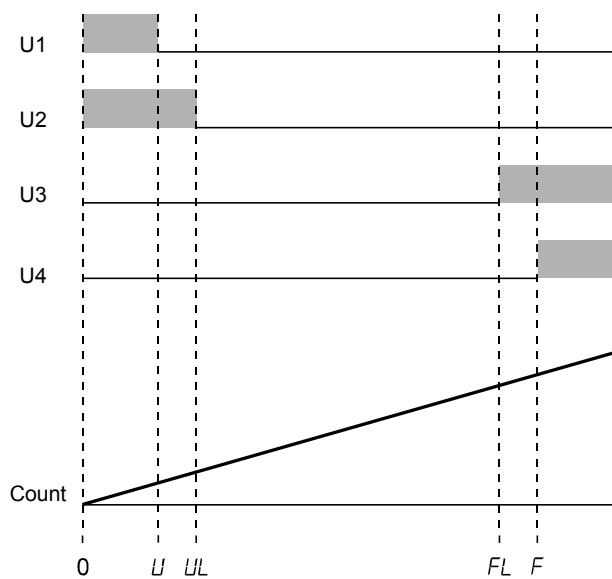

U = Min quota

UL = Min slow-down

FL = Max slow-down

F = Max quota

U1 is excited with:

Count ≤ Min quota

U2 is excited with:

Count ≤ Min quota + Min slow-down

U3 is excited with:

Count ≥ Max quota – Max slow-down

U4 is excited with:

Count ≥ Max quota

8.2.2 With parameter "E" = 2 or 3

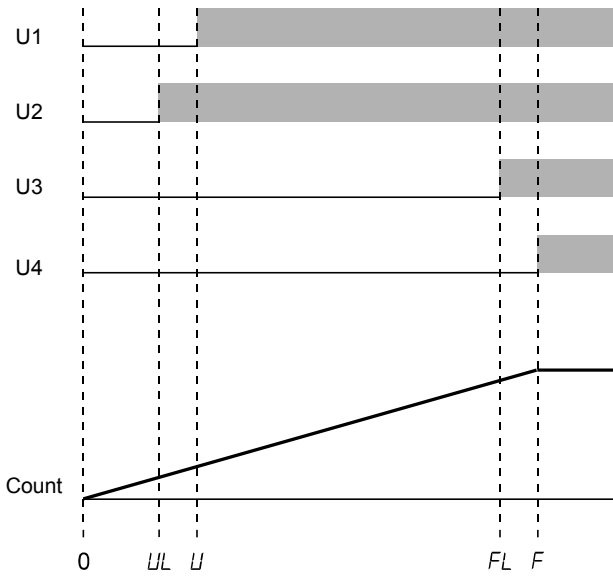

U = Min quota
 U/L = Min slow down
 FL = Max slow down
 F = Max quota

U1 is excited with:
 Count \geq Min quota

U2 is excited with:
 Count \geq Min quota - Min slow down

U3 is excited with:
 Count \geq Max quota - Max slow down

U4 is excited with:
 Count \geq Max quota



When F quota is reached the counter will be blocked and U4 output remain enabled up to the next counter reset.

8.2.3 With parameter "E" = 4

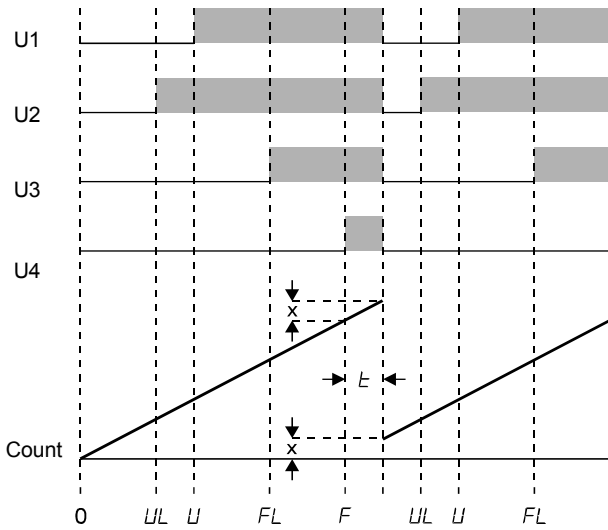

x = results of the difference between count and quota.

- U = Min quota
- UL = Min slow down
- FL = Max slow down
- F = Max quota
- E = Timer

U1 is excited with:
Count \geq Min quota

U2 is excited with:
Count \geq Min quota - Min slow down

U3 is excited with:
Count \geq Max quota - Max slow down

U4 is excited with:
Count \geq Max quota

8.2.4 With parameter "E" = 5

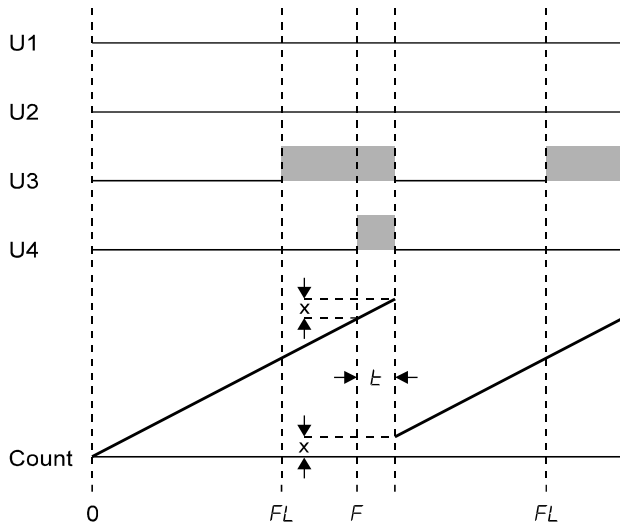

x = result of the difference between the count and the quota.

FL = Max slow down
 F = Max quota
 E = Timer

U1 not used

U2 not used

U3 is excited with:
 Count \geq Max quota - Max slow down

U4 is excited with:
 Count \geq Max quota

8.3 Using examples

8.3.1 Control for automatic spray painting machines

Encoder in the motor traslations

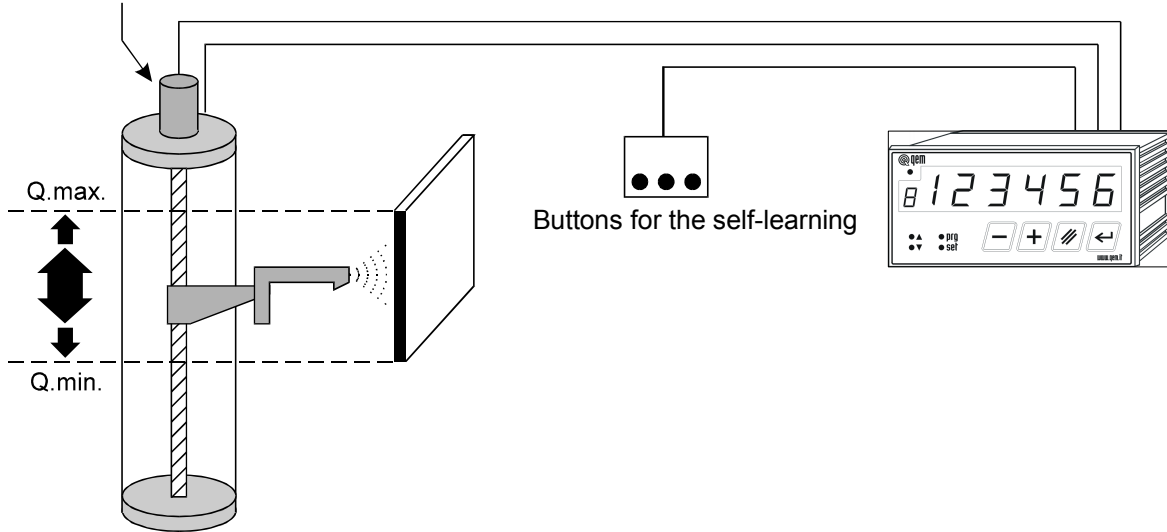

- Ways of functioning (set up parameter E set to 0 or 1)
- Output U1 (min quota)
- Output U2 (min quota slow-down)
- Output U3 (max quota slow-down)
- Output U4 (max quota)
- Input I1 (max quota self-learning)
- Input I2 (min quota self-learning)

8.3.2 Separation and outdistance of material on a belt

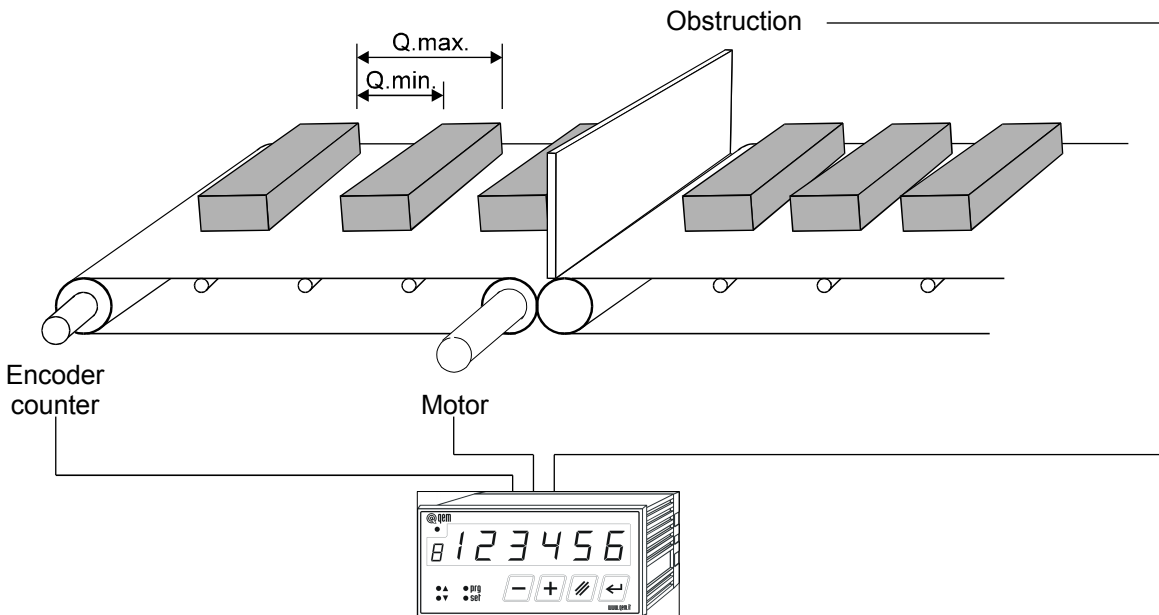

Ways of functioning (set-up parameter E set to 4)

- Output U1 (lift the obstruction)
- Output U4 (low the obstruction)

9. Assistance

9.1 Request of assistance

To provide you a faster service, at a minimum cost, we do need your help.



a)

a) Follow all the information in the manual MIMAT (www.qem.it)



b)

b) If the problem persists, fill the **Module for technical service** attached to this manual and send it to QEM.



c)

c) Our technicians will get the fundamentals elements to understand your problem.

9.2 Shipment

We recommend to pack the instrument with materials that can damp eventual falls.

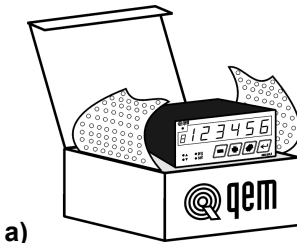

a)

a) Use the **original package**: it has to protect the instrument during the transportation.

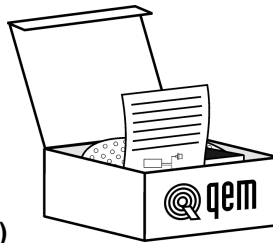

b)

b) **Attach**:

- An anomaly description;
- Part of the electrical sketch where the instrument is inserted
- Programming of the instrument (set up, working quotes, parameters..).
- **Request of a repairing estimate**; if not requested the cost will be calculated at the end.



c)

c) An exhaustive description of the problem allows to find and solve your problem. An accurate package avoids further drawbacks.

QEM informs the courteous customer that the shipped instruments unfairly packed won't be repaired, except for the cases where the customer assumes completely the reparation cost.

Motivations

The QEM established like that because a too strong line may cause damages that could reveal in a temporal space of some months, causing doubts and shadows on the reparation done.

Modulo per Assistenza Tecnica

Module for Technical Service

Ditta / Firm : Rif :

Indirizzo / Address:

Tel..... Fax.....

E – mail.....

Codice strumento / Instrument Code :

Alimentazione strumento / Power Supply:

Tipo di macchina / Machine type:
.....
.....
.....
.....

Descrizione ciclo macchina / Cycle machine description:
.....
.....
.....
.....

Parametri / Parameters:
.....
.....
.....
.....
.....
.....
.....
.....
.....
.....

Descrizione anomalia / Anomaly Description:
.....
.....
.....
.....

Frequenza anomalia / Anomaly frequency :

- Continuo / Continuous
- Saltuario / Irregular
- Dopo un certo tempo / After a few time
- All'accensione / At the switching on
- Allo spegnimento / At the switching off
- Altro / **Other** :

.....
.....
.....
.....





QEM S.r.l.
S.S. 11 Signolo n. 36,
36054 Montebello Vic. No
Vicenza – ITALY

Tel. +39 0444 440061
Fax + 39 0444 440229

<http://www.qem.it>
e-mail: info@qem.it



The CE mark of the instrument doesn't release the installer from the acknowledgement and the accomplishment of the prescriptive reference obligation of his product.