

Servo solenoid valves with electrical position feedback (LvdT DC/DC ± 10 V)

RE 29028/01.05
Replaces: 09.03

1/10

Type 4WRPH 6

Size 6
Unit series 2X
Maximum working pressure P, A, B 315 bar, T 250 bar
Nominal flow rate 2...40 l/min (Δp 70 bar)



List of contents

Contents	Page
Features	1
Ordering data and scope of delivery	2
Preferred types	2
Function, sectional diagram	3
Symbols	3
Technical data	4
Valve with external trigger electronics	5 and 6
Performance curves	7 and 8
Unit dimensions	9

Features

- Directly operated servo solenoid valve NG6, with control piston and sleeve in servo quality
- Actuated on one side, 4/4 fail-safe position when switched off
- Control solenoid with integral position feedback and electronics for position transducer (LvdT DC/DC)
- Suitable for electrohydraulic controllers in production and testing systems
- For subplate attachment, mounting hole configuration to ISO 4401-03-02-0-94
- Subplates as per catalogue section RE 45053 (order separately)
- Line sockets to DIN 43560-AM2
Solenoid 2P+PE/M16 x 1.5, position transducer 4P/Pg7 in scope of delivery, see catalogue section RE 08008
- External trigger electronics (order separately)
 - Electric amplifier for standard curve "L"
0 811 405 060, see catalogue section RE 30041
 - Electric amplifier for non-linear curve "P"
40 % – 0 811 405 065 and 60 % – 0 811 405 066, see catalogue section RE 30040

Variants on request

- For standard applications
- Special symbols for plastic machines
- Sturdy "ruggedized" version for applications up to 40 g, valve with metal cap and central plug (7P).

Ordering data and scope of delivery

4WRP		H	6		B		-2X/G24	Z4/ M	*
-------------	--	----------	----------	--	----------	--	----------------	--------------	----------

For external trigger electronics = no desig.

Control piston/sleeve = H

Size 6 = 6

Symbols

4/4-way version

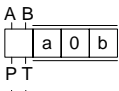

= C3, C5

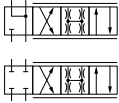

= C4, C1

With symbols C5 and C1:³⁾
 P → A: q_v B → T: $q_v/2$
 P → B: $q_v/2$ A → T: q_v

Side of inductive position transducer

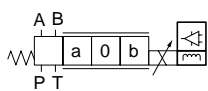

(Standard) = B

¹⁾ Only in connection with flow characteristic "p"
²⁾ Kink 60% for NG6 with nominal flow rate "15" and "25", otherwise kink 40%
³⁾ q_v 2:1 only with nominal flow rate = 40 l/min

Further information in plain text

M = NBR seals, suitable for mineral oils (HL, HLP) to DIN 51524

Electrical connection
 Z4 = with line socket, with plug to DIN 43560-AM2
 Line socket in scope of delivery

Voltage supply of trigger electronics
 G24 = +24V DC

2X = Unit series 20 to 29 (installation and connection dimensions unchanged)

Flow characteristic
 L = Linear
 P = Non-linear curve²⁾

Nominal flow rate at 70 bar valve pressure difference (35 bar /metering notch)

Size 6

02 = 2 l/min
 04 = 4 l/min
 12 = 12 l/min
 15¹⁾ = 15 l/min
 24 = 24 l/min
 25¹⁾ = 25 l/min
 40³⁾ = 40 l/min

Preferred types (available at short notice)

Type 4WRPH 6	Material no.	Type 4WRPH 6	Material no.
C3/C5		C1/C4	
4WRPH 6 C3B02L -2X/G24Z4 / M	0 811 404 041	4WRPH 6 C4B02L -2X/G24Z4 / M	0 811 404 512
4WRPH 6 C3B04L -2X/G24Z4 / M	0 811 404 033	4WRPH 6 C4B04L -2X/G24Z4 / M	0 811 404 160
4WRPH 6 C3B12L -2X/G24Z4 / M	0 811 404 034	4WRPH 6 C4B12L -2X/G24Z4 / M	0 811 404 037
4WRPH 6 C3B24L -2X/G24Z4 / M	0 811 404 035	4WRPH 6 C4B24L -2X/G24Z4 / M	0 811 404 038
4WRPH 6 C3B40L -2X/G24Z4 / M	0 811 404 036	4WRPH 6 C4B40L -2X/G24Z4 / M	0 811 404 039
4WRPH 6 C5B40L -2X/G24Z4 / M	0 811 404 510	4WRPH 6 C1B40L -2X/G24Z4 / M	0 811 404 513
4WRPH 6 C3B15P -2X/G24Z4 / M	0 811 404 047	4WRPH 6 C4B15P -2X/G24Z4 / M	0 811 404 048
4WRPH 6 C3B25P -2X/G24Z4 / M	0 811 404 043	4WRPH 6 C4B25P -2X/G24Z4 / M	0 811 404 045
4WRPH 6 C3B40P -2X/G24Z4 / M	0 811 404 044	4WRPH 6 C4B40P -2X/G24Z4 / M	0 811 404 046
4WRPH 6 C5B40P -2X/G24Z4 / M	0 811 404 511	4WRPH 6 C1B40P -2X/G24Z4 / M	0 811 404 162

Function, sectional diagram

Servo solenoid valve 4WRPH6

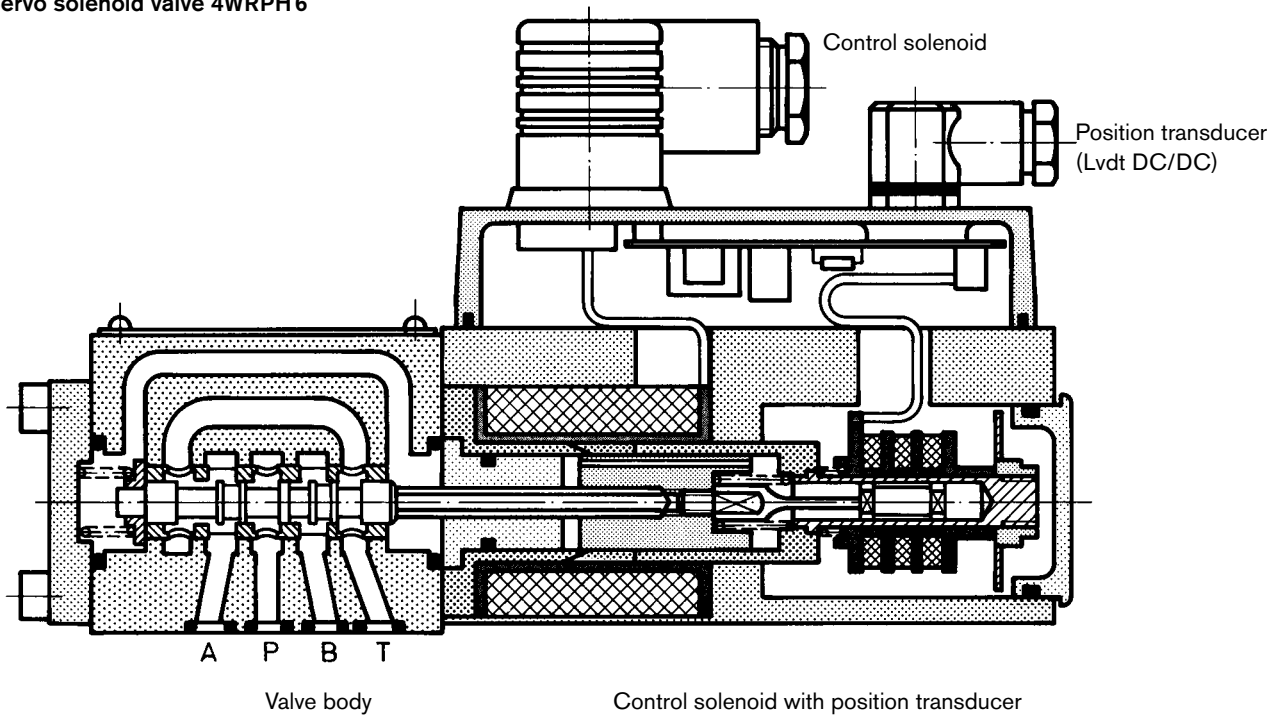

Symbols

	Linear	p: kink 60% [q_n 15,25 l/min]	p: kink 40% [q_n 40 l/min]
C3, C5, C4, C1 Standard = 1:1, from q_n 40 l/min also 2:1			

Accessories, not included in scope of delivery

(4x) M5x30 DIN 912-10.9	Fastening screws	2910 151 166
	VT-VRRA1-527-20/V0, see RE 30041	0811 405 060
	VT-VRRA1-527-20/V0/K60-AGC, see RE 30040	0811 405 066
	VT-VRRA1-527-20/V0/K40-AGC, see RE 30040	0811 405 065
	2P+PE (M16x1.5) and 4P (Pg7) included in scope of delivery, see also RE 08008	

Application

– Valve amplifier with pressure compensator (p/Q), see RE 30058.

Testing and service equipment





- Test box type VT-PE-TB2, see RE 30064.
- Test adapter type VT-PA-3, see RE 30070.

Technical Data

General

Construction	Spool type valve, operated directly, with steel sleeve					
Actuation	Proportional solenoid with position control, external amplifier					
Type of mounting	Subplate, mounting hole configuration NG6 (ISO 4401-03-02-0-94)					
Installation position	Optional					
Ambient temperature range	°C	-20 ... +50				
Weight	kg	2.3				
Vibration resistance, test condition	Max. 25 g, shaken in 3 dimensions (24 h)					

Hydraulic (measured with HLP 46, $\vartheta_{oil} = 40^\circ\text{C} \pm 5^\circ\text{C}$)

Pressure fluid	Hydraulic oil to DIN 51524 ... 535, other fluids after prior consultation						
Viscosity range	recommended	mm ² /s	20 ... 100				
	max. permitted	mm ² /s	10 ... 800				
Pressure fluid temperature range	°C	-20 ... +80					
Maximum permissible degree of contamination of pressure fluid Purity class to ISO 4406 (c)	Class 18/16/13 ¹⁾						
Flow direction	See symbol						
Nominal flow at $\Delta p = 35$ bar per notch ²⁾	l/min	2	4	12	15	24	40
Max. working pressure	bar	Port P, A, B: 315					
Max. pressure	bar	Port T: 250					
Operating limits at Δp Pressure drop at valve	 bar	315	315	315	315	315	160
$q_{Vnom} > q_N$ valves	 bar	315	315	315	280	250	100
Leakage at 100 bar	 cm ³ /min	<150	<180	<300	-	<500	<900
	 cm ³ /min	-	-	-	<180	<300	<450

Electrical

Cyclic duration factor	%	100 ED				
Power supply	24 V _{nom} (external amplifier)					
Degree of protection	IP 65 to DIN 40050					
Solenoid connector	Connector DIN 43650/ISO 4400 M16 x 1.5 (2P + PE)					
Position transducer connector	Special Connector Pg7 (4P)					
Max. solenoid current	A	2.7				
Coil resistance R_{20}	Ω	2.5				
Max. power consumption at 100% load and operational temperature	VA	40				
Position transducer DC/DC technology	Supply: +15 V/35 mA -15 V/35 mA			Signal: 0...±10 V ($R_L \geq 10$ kΩ)		

Static/Dynamic

Hysteresis	%	≤ 0.2
Manufacturing tolerance for q_{max}	%	< 10
Response time for signal change 0 ... 100 %	ms	< 10
Thermal drift	Zero point displacement < 1 % at $\Delta T = 40^\circ\text{C}$	

¹⁾ The purity classes stated for the components must be complied with in hydraulic systems. Effective filtration prevents problems and also extends the service life of components. For a selection of filters, see catalogue sections RE 50070, RE 50076 and RE 50081.

²⁾ Flow rate at a different Δp $q_x = q_{nom} \cdot \sqrt{\frac{\Delta p_x}{35}}$

Valve with external trigger electronics (standard linear curve: L)

Block diagram/pin assignment

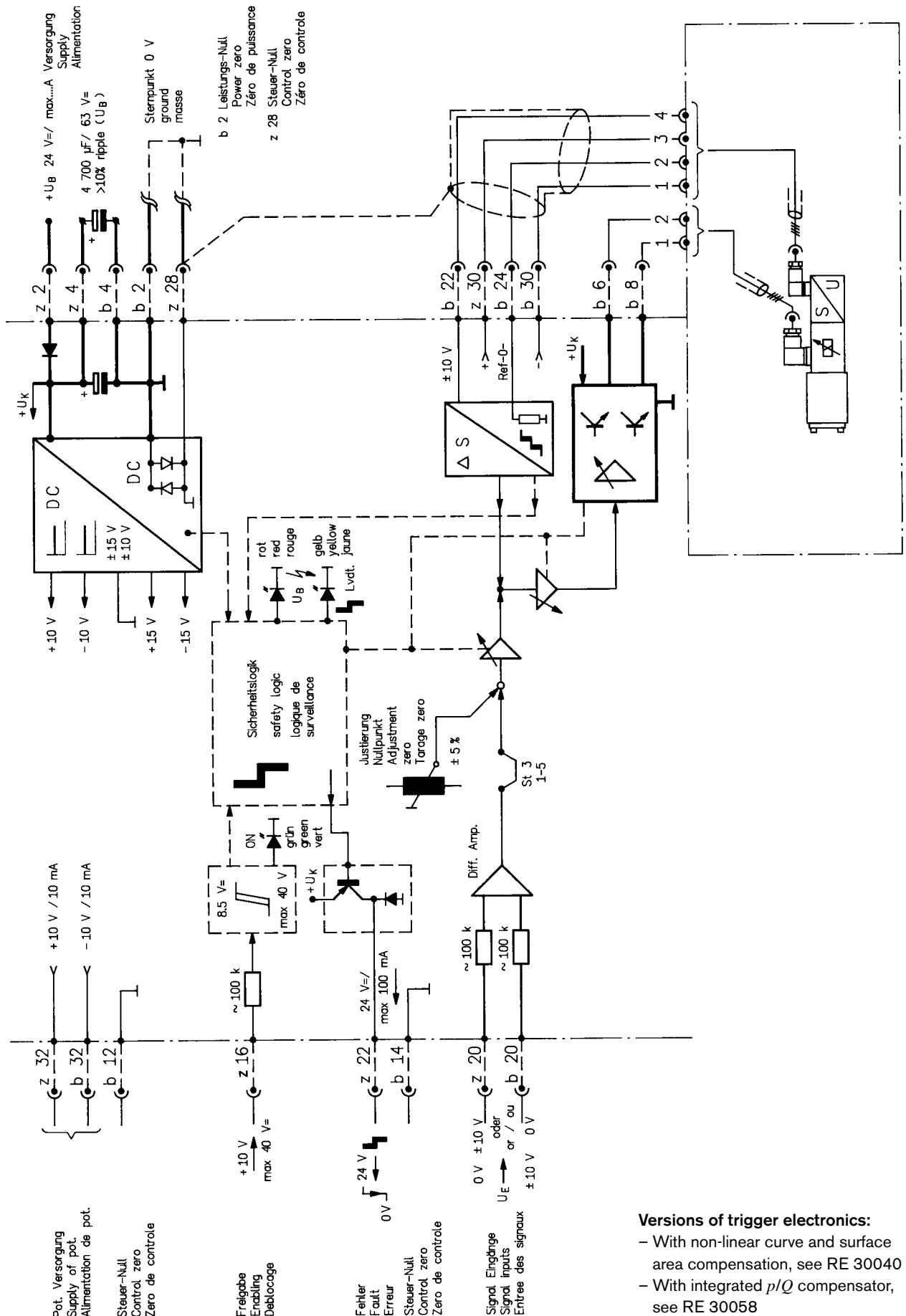

Valve with external trigger electronics (non-linear curve: P)

Block diagram/pin assignment

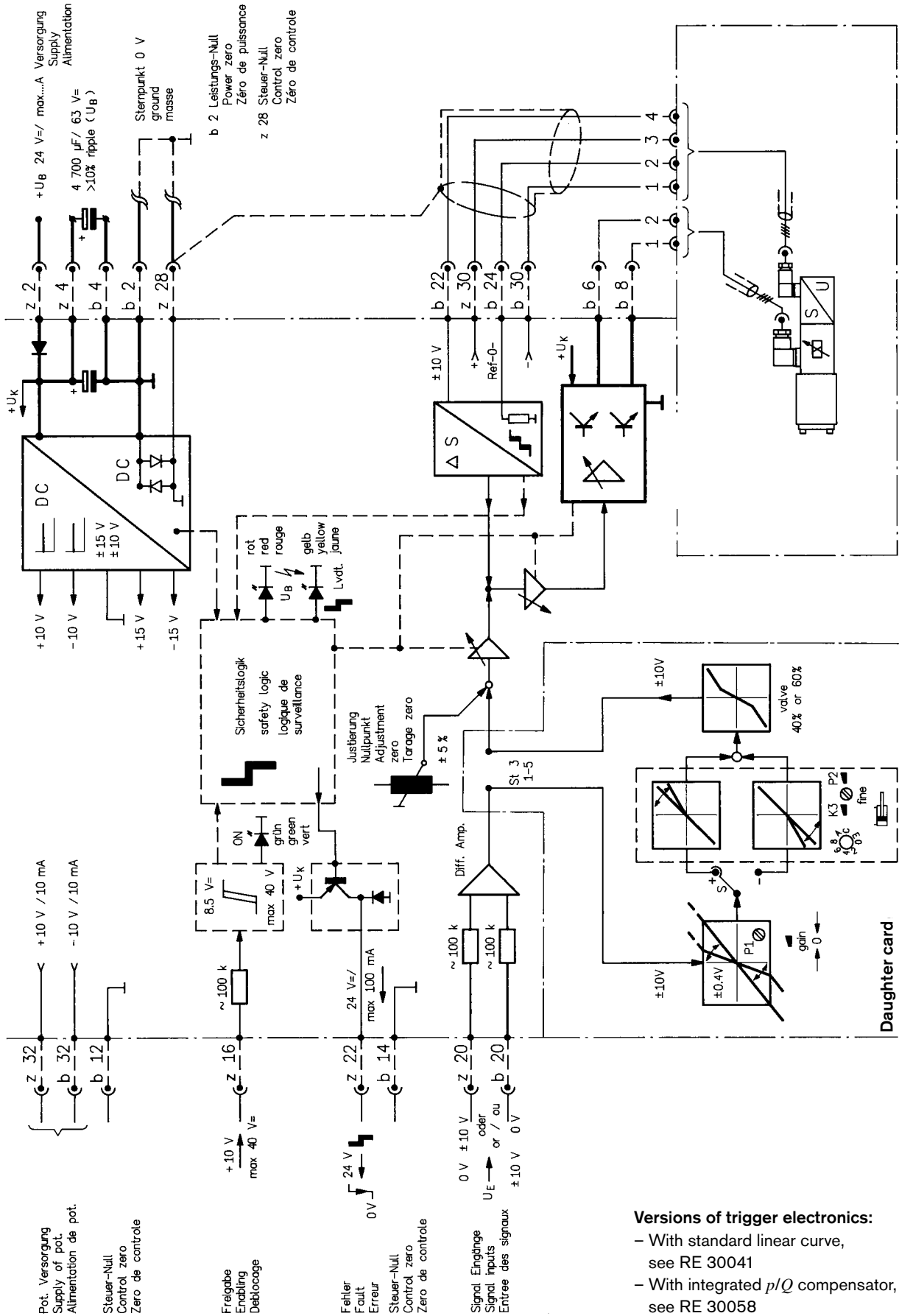

Performance curves (measured with HLP46, $\vartheta_{oil} = 40^\circ\text{C} \pm 5^\circ\text{C}$)

Flow rate/Signal function $Q = f(U_E)$

L: Linear

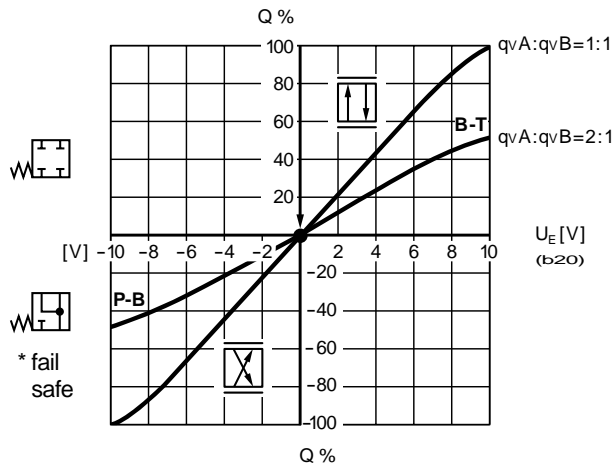

P: (kink 60%)**

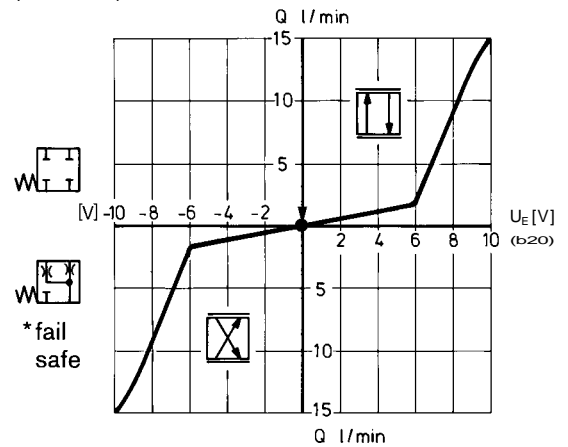

P: (kink 60%)

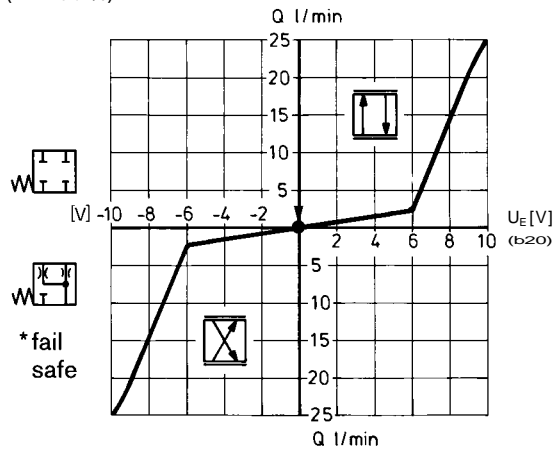

P: (kink 40%)**

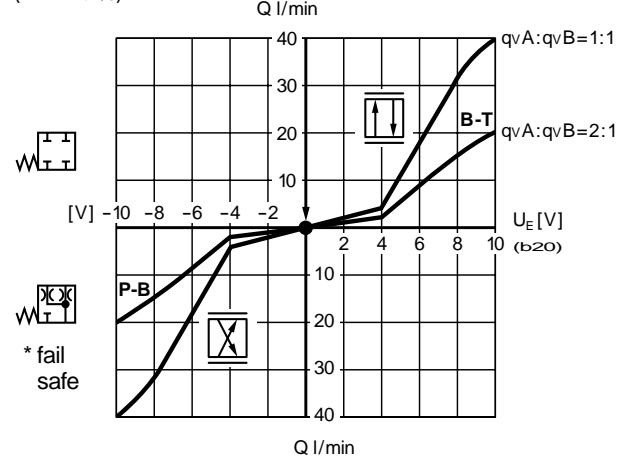

*Fail-safe when enabling is not released.

** $Q_{\text{kink}} = 10\% Q_N$.

		Fail-safe position			
	Leakage at	100 bar	P-A	50 cm ³ /min	
			P-B	70 cm ³ /min	
	Flow rate at	$\Delta p = 35$ bar	A-T	10 ... 20 l/min	
			B-T	7 ... 20 l/min	
	Leakage at	100 bar	P-A	50 cm ³ /min	
			P-B	70 cm ³ /min	
			A-T	70 cm ³ /min	
			B-T	50 cm ³ /min	
	Fail-safe	$p = 0$ bar \rightarrow 7 ms	Enable off		
		$p = 100$ bar \rightarrow 10 ms			

Performance curves (measured with HLP 46, $\vartheta_{oil} = 40^\circ\text{C} \pm 5^\circ\text{C}$)

Pressure gain

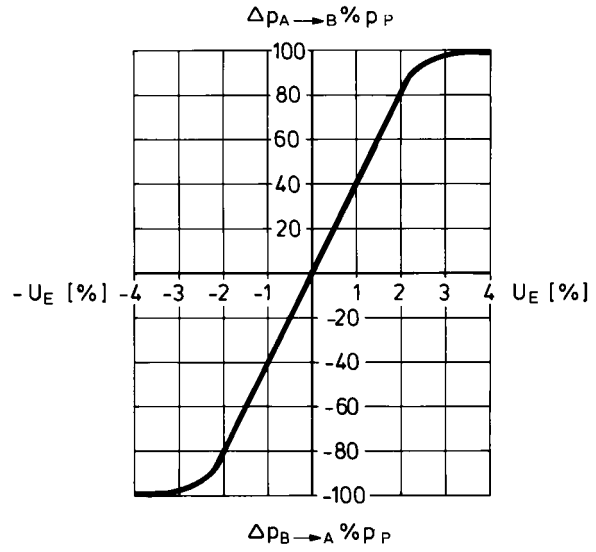
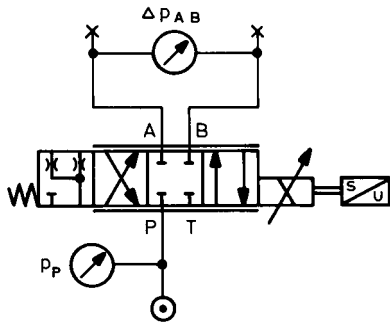

Bode diagram

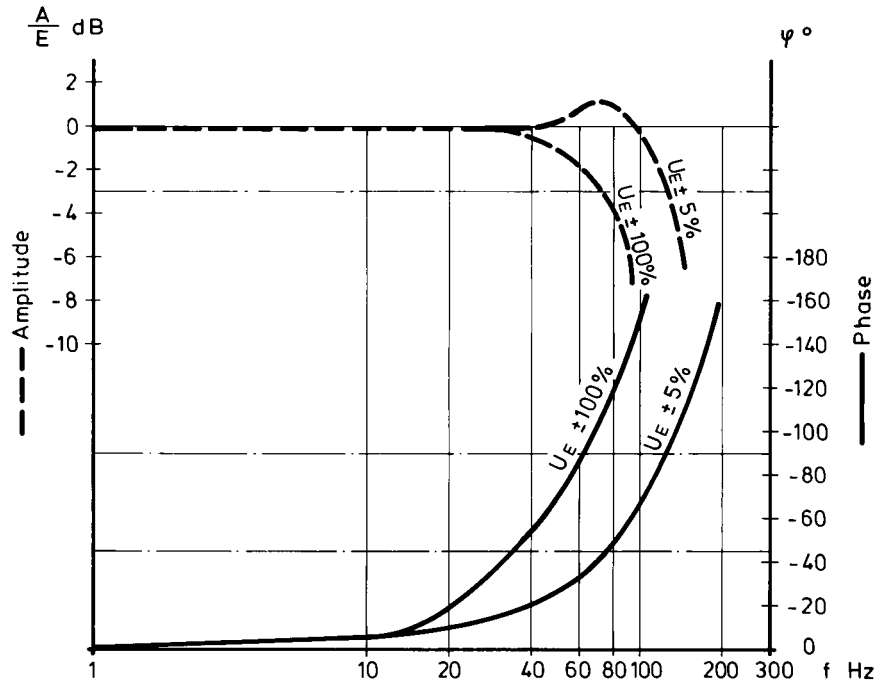
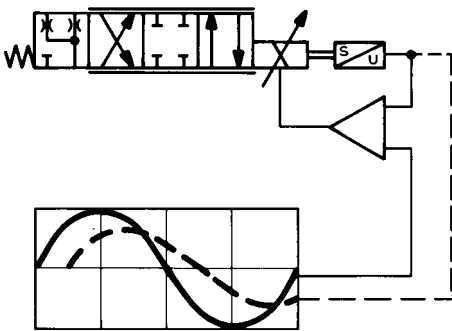

Unit dimensions (nominal dimensions in mm)

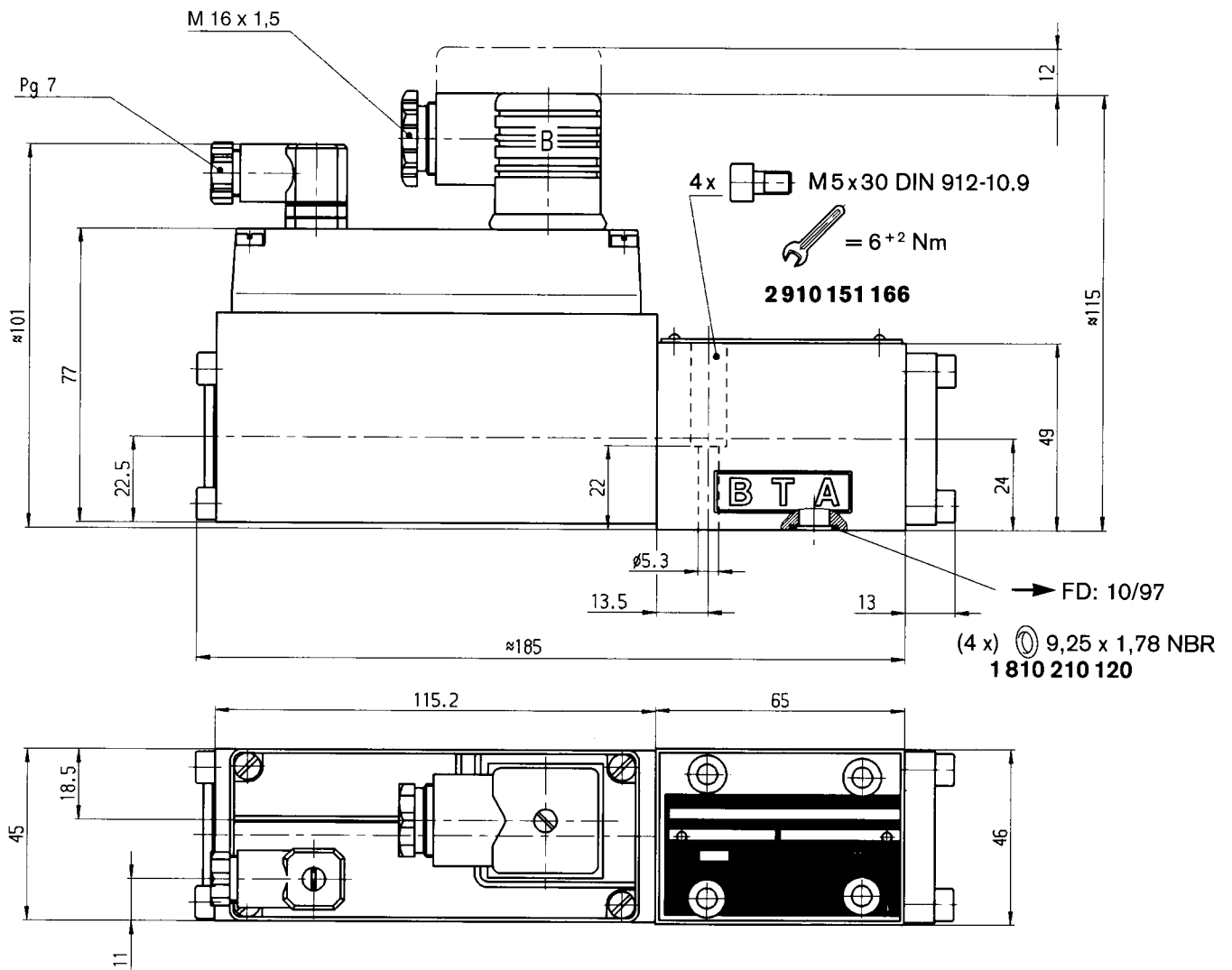

Required surface quality of mating component

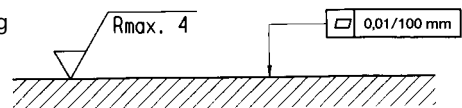

Mounting hole configuration: NG6 (ISO 4401-03-02-0-94)
 For subplates, see catalogue section RE 45053

- 1) Deviates from standard
- 2) Thread depth:
 Ferrous metal 1.5 x Ø
 Non-ferrous 2 x Ø

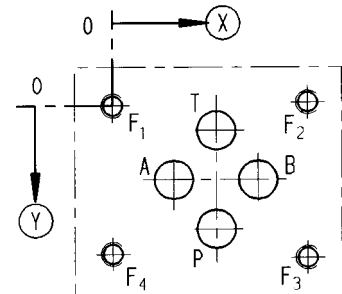

	P	A	T	B	F ₁	F ₂	F ₃	F ₄
⊗	21.5	12.5	21.5	30.2	0	40.5	40.5	0
⊙	25.9	15.5	5.1	15.5	0	-0.75	31.75	31
∅	8 ¹⁾	8 ¹⁾	8 ¹⁾	8 ¹⁾	M5 ²⁾	M5 ²⁾	M5 ²⁾	M5 ²⁾

Notes

Notes

Notes
