

Switching Power Supply Type SPD 300W DIN rail mounting

CARLO GAVAZZI

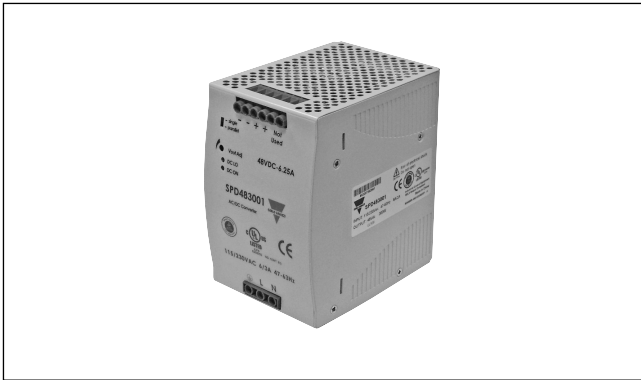

- Installation on DIN Rail 7.5 or 15mm
- Short circuit protection
- Passive PFC
- Power ready relay output on 24VDC
- LED indicator for DC power ON
- LED indicator for DC low
- Parallel function by switch
- Very compact dimensions
- UL, cUL listed and TUV/CE approved
- Class I division 2 certification
- Selv design

Product Description

This SPD is the most compact 300W power supply on the market. Relay output for “power ready” parallel function and PFC are included. Performances are unique with high efficiencies and the possibility of being used up to 70°C with a little derating. Thanks to the Class I Div 2 design is suitable for installation in potentially explosive environments.

Ordering Key

SP D 24 300 1 B

Model _____
 Mounting (D= Din rail) _____
 Output voltage _____
 Output power _____
 Input type _____
 Connection _____

Input type: 1= single phase
 Connection: Nil= screw terminals
 B= Detachable connectors

Approvals



Output performances

MODEL NO.	INPUT VOLTAGE	OUTPUT WATTAGE	OUTPUT VOLTAGE	OUTPUT CURRENT	EFF. (min.)	EFF. (typ.)
Single Output Models						
SPD24300	115~230 VAC	300 WATTS	+ 24 VDC	12.5 A	87%	89%
SPD48300	115~230 VAC	300 WATTS	+ 48 VDC	6.25 A	88%	90%

Output data

Line regulation	± 0.5%	Hold up time Vi115/230 VAC	25/30 ms
Load regulation	± 1%	Voltage fall time (I _{0nom})	150ms max
Minimum load		Rated continuous loading	
Single mode	± 1%	24V Model	12.5A @ 24VDC/10.5A @ 28.5VDC
Parallel mode	± 5%	48V Model	6.25A @ 48VDC/5.35A @ 56VDC
Turn on time (full resistive load)		Reverse voltage	
Vi nom, I _o nom	1000ms	24V Model	35VDC
Vi nom, I _o nom with 7000µF CAP	1500ms	48V Model	63VDC
Transient recovery time	2ms	Capacitor load	
Ripple and noise	100mVpp	Vi nom I _o nom	7000µF
Output voltage accuracy	± 1%	Voltage rise time	
Temperature coefficient	± 0.03%/°C	Vi nom I _o nom	150ms
		Vi nom, I _o nom	
		12v model with 7000µF CAP	500ms

Input data

Rated input voltage	115 - 230VAC	Power dissipation	
Voltage range		24V Model	42W
AC in 115V selected	90 - 132VAC	48V Model	40W
AC in 230V selected	180 - 264VAC	Frequency range	47- 63Hz
DC in	210 - 375VDC	Leakage current	
Rated input current (Vi : 90/180VAC, Io nom)	Typ. 6.0A	Input-Output	0.25mA
	Max. 3.0A	Input-FG	3.5mA
Inrush current Vi= 115/230VAC	35 - 65A		

Controls and Protections

Overload	120-145%	Over voltage protection	125 - 140%
Input fuse	T8A/250VAC internal ¹⁾	Internal surge voltage protection (IEC 61000-4-5)	Varistor
Output short circuit	Fold forward		
Power ready output (only 24V model)	On threshold ≥17.6 -19.4VDC		
Electrical isolation	500VDC		
Contact rating at 60Vdc	0.3A		

¹⁾ Fuse not replaceable by user

General data (@ nominal line, full load, 25°C)

Ambient temperature	-30°C to 71°C	MTBF (Bellcore issue 6 @ 40°C, GB)	
Derating (>56°C to +71°C)	2.5%/°C	24V Model	415000 Hours
Ambient humidity	20 ~ 90%RH	48V Model	431000 Hours
Storage	-40°C to +85°C	Case material	Metal
Protection degree	IP20	Dimensions LxWxD mm(inch)	124(4.88) x 83.5(3.29) x 123.6(4.87)
Cooling	Free air convection	Weight	1400g
Pollution degree	2		

Norms and Standards

Vibration resistance	meet IEC 60068-2-6 (Mounting by rail: 10-500Hz, 2G, along X, Y, Z each Axis, 60 min for each Axis)	CE	EN 61000-6-3, EN 55022 Class B, EN 61000-3-2 Class D, EN 61000-3-3, EN 61000-6-2, EN 55024, EN 61000-4-2 Level 4, EN 61000-4-3 Level 3, EN 61000-4-4 Level 4, EN 61000-4-5 L-N Level 3, L/N-FG Level 4, EN 61000-4-6 Level 3, EN 61000-4-8 Level 4, EN 61000-4-11, ENV 50204 Level 2, EN 61204-3
Shock resistance	meet IEC 60068-2-27 (15G, 11ms, 3 Axis, 6 faces, 3 times for each face)		
UL / cUL	UL508 listed, UL60950-1, Recognized, ISA 12.12.01 (Class 1, Division 2, Groups A, B, C and D)		
TUV	EN 60950-1, CB scheme EN 61558-1, EN 61558-2-17 (meet EN 60204)		

Block Diagrams

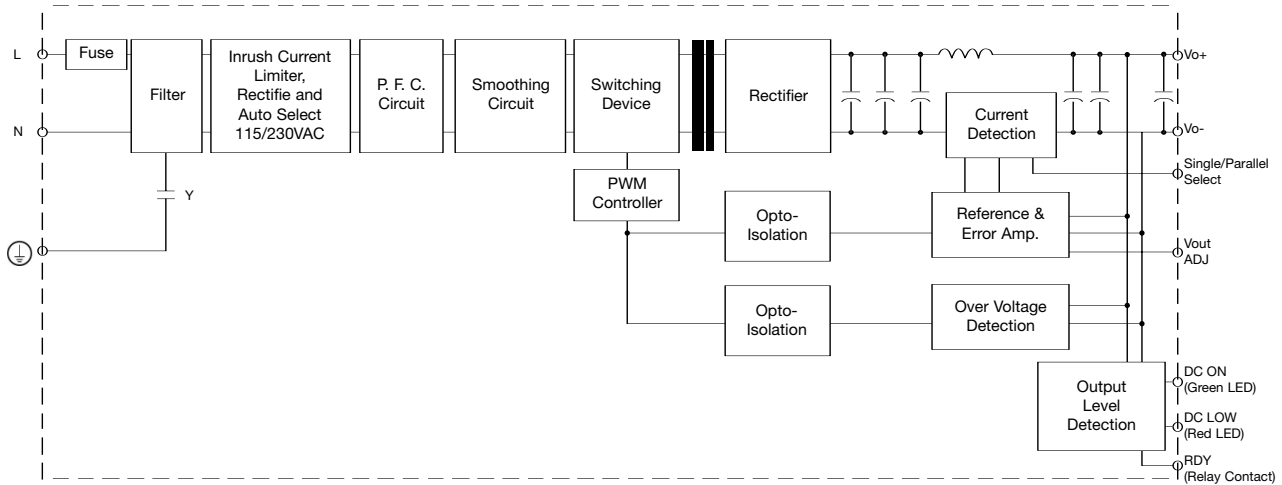

Pin Assignment and Front Controls

Pin No.	Designation	Description
1	RDY	A normal open relay contact for DC ON level control
2		(Never connect except 24V model)
3, 4	V+	Positive output terminal
5, 6	V-	Negative output terminal
7		Ground this terminal to minimize high-frequency emissions
8	L	Input terminals (phase conductor, no polarity at DC input)
9	N	Input terminals (neutral conductor, no polarity at DC input)
	DC ON	Operation indicator LED
	DC LO	DC LOW voltage indicator LED
	Vout Adj	Trimmer-potentiometer for Vout adjustment
	S/P	Single / Parallel select switch

Derating Diagram

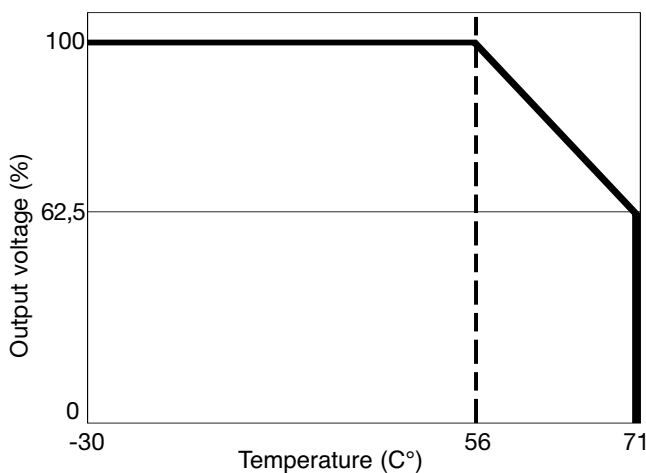

Typ. Efficiency Curve

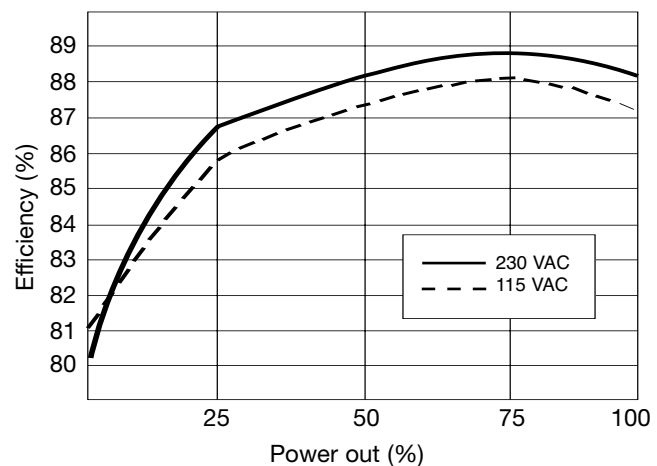

Typ. Current Limited Curve

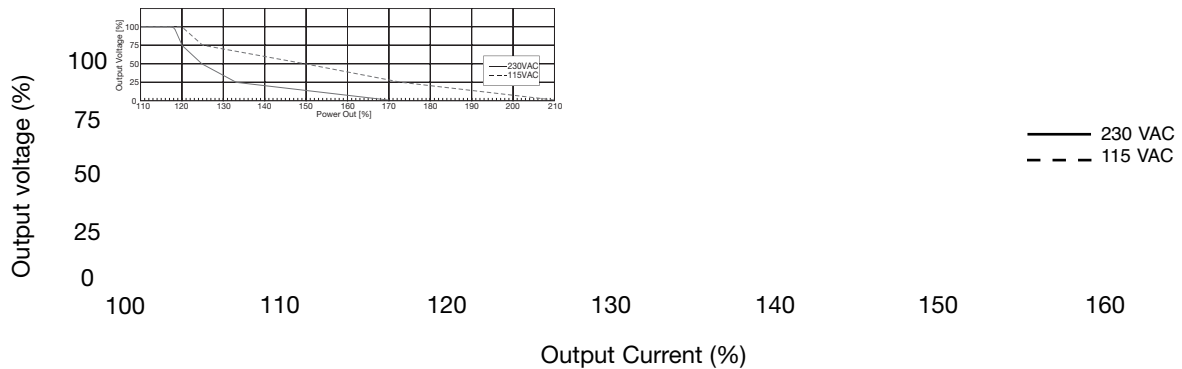

Mechanical Drawings mm (inches)

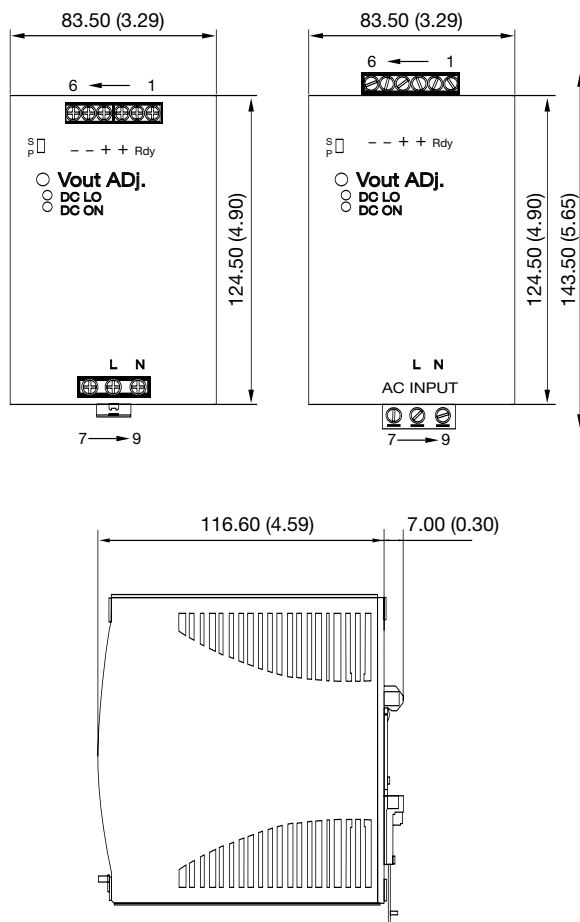

Installation

Ventilation and cooling	Normal convection All sides 25mm free space for cooling is recommended
Screw terminals	10-24AWG flexible or solid cable 8mm stripping recommend
Max. torque for screws terminals	Input terminals 1.008Nm (9.0lb-in) Output terminals 0.616Nm (5.5lb-in)
Max. torque for detachable connections	Input terminals 1.008Nm (9.0lb-in) Output terminals 0.616Nm (5.5lb-in)
Plug-in connectors	10-24AWG flexible or solid cable 7mm stripping recommend
Max. torque for plug-in terminals	Input terminals 0.784Nm (7.0lb-in) Output terminals 0.784Nm (7.0lb-in)
Recommended circuit breaker	15A / 16A B, D characteristics

Mouser Electronics

Authorized Distributor

Click to View Pricing, Inventory, Delivery & Lifecycle Information:

[Carlo Gavazzi:](#)

[SPD243001](#)