

## ELETTROVALVOLE MAX-AIR

5/2 - 3/2

## MAX-AIR SOLENOID VALVES



# CARATTERISTICHE E VANTAGGI

## FEATURES & BENEFITS

Max-Air introduce la Serie EV, un range completo di Elettrovalvole a spola, progettate secondo le norme NAMUR VDI/VDE 3385 od in versione inline, realizzate in alluminio anodizzato o acciaio inossidabile AISI 316.

La serie EV è disponibile nella versione monostabile, bistabile o a 3 posizioni (centri aperti, centri chiusi e centri in pressione). Ogni elettrovalvola NAMUR può essere utilizzata con attuatori a Doppio Effetto (applicazione a 5 vie) o a Semplice Effetto (3 vie).

### COMANDO MANUALE

Le elettrovalvole sono equipaggiate con il comando manuale di serie che consente di azionare l'elettrovalvola anche in mancanza di aria e/o per un rapido test di funzionamento.

### CONFIGURAZIONE STANDARD PER NAMUR

Funzionamento a 3 vie/2 posizioni (Attuatori Semplice Effetto) oppure 5 vie/2 posizioni (Doppio Effetto) con una piastrina inclusa (per la 3/2).

### VERSIONI

Ogni elettrovalvola della serie EV è disponibile in versione monostabile, bistabile e, solo per le NAMUR, a 3 posizioni centri chiusi (E36C) o centri aperti (E36A).

### ZONE PERICOLOSE

La serie EV è disponibile con vari gradi di protezione per poter essere installate in zone pericolose secondo le normative europee (ATEX) e americane (CSA/UL).

### INGRESSI ARIA

Le elettrovalvole NAMUR EV hanno ingressi e scarichi 1/4"G (o NPT), mentre la versione inline è disponibile con attacchi 1/4"G (N) o 1/2"G (N). Gli attacchi standardizzati facilitano la connessione con le linee pneumatiche e l'utilizzo di silenziatori e regolatori di flusso.

### ARIA DI ALIMENTAZIONE

La serie EV lavora con pressioni da 2 a 8 Bar con aria lubrificata e non. Si consiglia di utilizzare un filtro Max-Air in ingresso per garantire la pulizia dell'aria e la corretta pressione.

Max-Air offers the EV series, a complete range of spool and direct acting solenoid valves, designed according NAMUR VDI/VDE 3385 standard and Inline type, both in anodized aluminum and stainless steel AISI316.

EV series is available as single coil, dual coils and 3 position configuration. Each NAMUR solenoid valve is field interchangeable for use on either double acting 5-Way or spring return 3-Way actuators.

### MANUAL OVERRIDE

Each SV solenoid valve comes standard with a lockable manual override. This is an important feature because it allows the solenoid valve to be used manually in case of electrical failure, or for quick cycle testing.

### STANDARD NAMUR CONFIGURATION

The Max-Air EV series solenoid valve features an anodized aluminum spool, easy to use manual override, and comes standard as 5-Way (Double Acting) with an optional adapter plate for 3-Way (Spring Return) field conversion.

### VERSION

Each EV series NAMUR mount solenoid valve is available in a single coil version (for example, EV61 & EV63), dual coil (EV62), open centers (E36A), and closed centers (E36C).

### HAZARDOUS LOCATION OPTIONS

The EV series is available in various explosion proof configurations for hazardous locations. According to the European standards (ATEX) and American (CSA / UL).

### AIR INLET/EXHAUST PORT CONNECTIONS

All NAMUR EV solenoid valves comes with 1/4" NPT air inlet and exhaust connections. The inline version instead is available with 1/4" G (N) or 1/2" G (N) pneumatic connections. This standard connection allows for ease in connecting all airlines and retrofitting each solenoid valve with the proper speed control or muffler.

### AIR SERVICE

Max-Air solenoid valves can be used with lubricated or non-lubricated air. It is recommended that a Max-Air filter regulator be used to keep the air quality clean which will extend the life of the solenoid valve



3-Way Conversion Kit



2 PILOTI / 2 PILOTS



3 POSITIONS



# SERIE NAMUR "61 - 62 - 63" - IP65 - ORDINARY LOCATION

La serie EV61 EV62 & EV63 sono elettrovalvole NAMUR IP65 compatte, leggere e di semplice utilizzo. Dotate di comando manuale di serie, può essere convertita da 5 a 3 vie sul campo grazie ad una piastrina di conversione fornita nel kit standard.

The EV61, EV62 and EV63 solenoid valves are a compact IP65 rated NAMUR mount solenoid valve that is lightweight and easy to use. This light-weight, compact solenoid offers a standard manual override and comes as a standard 4-Way with easy conversion to a 3-Way for spring return (single-acting) applications.

## DATI TECNICI - TECHNICAL DATA

Pressione di Lavoro	2-8 Bar (30-120PSI)	Working pressure
Grado di protezione	IP65	Protection Degree
Connessioni pneumatiche	¼"G (¼"N)	Pneumatic Connection
Connessioni Elettriche	DIN 43650B PG9 (½" N)	Electrical connection
Temperatura Ambiente	-20°C +60°C (-4°F +140°F)	Ambient Temperature
Area Installazione	Sicura - Safe Ex nA T4/T5 (Optional)	Area Protection
Bobina	Class F 100% Duty	Coil
Cv	1.1	Cv

## VOLTAGGI DISPONIBILI - COIL ELECTRICAL RATING

Voltaggio / Voltage	Power	Tolerance
12/24/48 VDC	3W	±10%
24/48/110/220 VAC	5VA	±10%

## MATERIALI - MATERIALS

Articolo	Materiale	Item	Material
Corpo	Alluminio Anodizzato/AISI316	Body	Anodized aluminum/ Stainless steel AISI 316
Spola	Alluminio Anodizzato/AISI316	Spool	Anodized aluminum/ Stainless steel AISI 316
Pilota	Ottone/Acciaio Inossidabile	Armature	Brass/Stainless steel
Molla	Acciaio/Acciaio inossidabile	Spring	Steel/Stainless steel
O Ring	NBR	O Ring	BUNA-N

### LEFT PILOT EV61

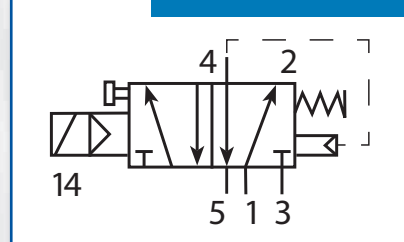

### RIGHT PILOT EV63

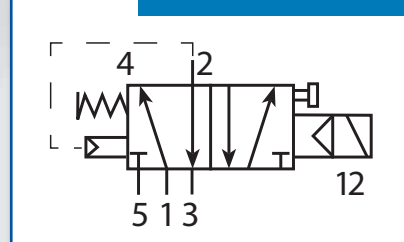

### DUAL COIL EV62

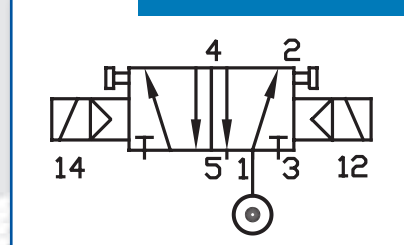

ATEX II 3GD



IP65



## EV 61 - DIMENSIONI / DIMENSIONS

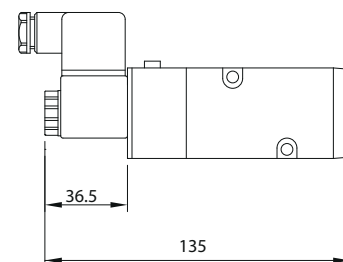
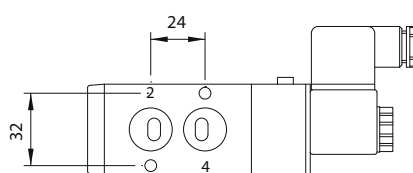
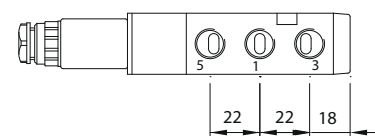
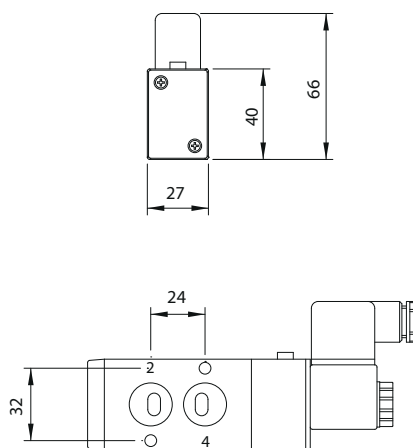

For EV63 & EV62 dimensions,  
please visit our web site

# SERIE NAMUR "71 - 72 - 73" - IP65 - INTRINSICALLY SAFE Exia IIC T4/T6

La serie EV71, EV72 & EV73 sono elettrovalvole NAMUR IP65 compatte, leggere e di semplice utilizzo, che possono essere utilizzate in applicazioni a Sicurezza Intrinseca. È importante notare che una corretta barriera deve essere utilizzata congiuntamente all'elettrovalvola. Dotate di comando manuale di serie, può essere convertita da 5 a 3 vie sul campo grazie ad una piastrina di conversione fornita nel kit standard. Compatibile con barriere Pepperl & Fuchs KFD2-SL2-Ex2 and KFD2-SD-Ex 1.36.

The EV71, EV72 and EV73 solenoid valves are a compact, light-weight solenoid that can be used in intrinsically safe applications. It is important to note that a proper safety barrier needs to be used in conjunction with the solenoid valve. Solenoids come standard with both 3-Way and 5-Way field conversion kits.

Compatible barriers to use are Pepperl & Fuchs KFD2-SL2-Ex2 and KFD2-SD-Ex 1.36.

## DATI TECNICI - TECHNICAL DATA

Pressione di Lavoro	2-8 Bar (30-120PSI)	Working pressure
Grado di protezione	IP65	Protection Degree
Conessioni pneumatiche	1/4"G (1/4"N)	Pneumatic Connection
Conessioni Elettriche	DIN 43650A PG9 (1/2" N)	Electrical connection
Temperatura Ambiente	-20°C +60°C (-4°F +140°F)	Ambient Temperature
Area di Installazione	A Sicurezza Intrinseca Ex ia IIC T6/T4 Intrinsically Safe	Area Protection
Bobina	Class F 100% Duty	Coil
Cv	1.1	Cv

## VOLTAGGI DISPONIBILI - COIL ELECTRICAL RATING

Voltaggio / Voltage	A	Max	I <sub>≤</sub>	P <sub>≤</sub>
24 VDC	0.05A	28VDC	115mA	1.6W

## MATERIALI - MATERIALS

Articolo	Materiale	Item	Material
Corpo	Alluminio Anodizzato/AISI316	Body	Anodized aluminum/ Stainless steel AISI 316
Spola	Alluminio Anodizzato/AISI316	Spool	Anodized aluminum/ Stainless steel AISI 316
Pilota	Ottone/Acciaio Inossidabile	Armature	Brass/Stainless steel
Molla	Acciaio/Acciaio inossidabile	Spring	Steel/Stainless steel
O Ring	NBR	O Ring	BUNA-N

### LEFT PILOT EV71

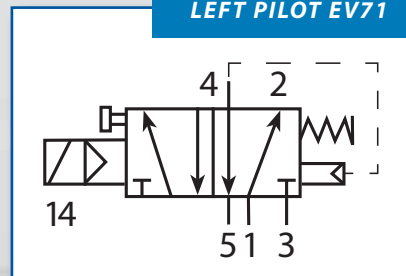

### RIGHT PILOT EV73

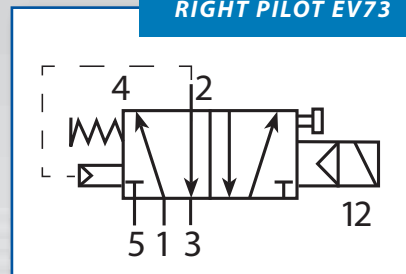

### DUAL COIL EV72

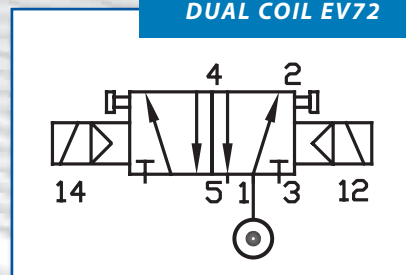

ATEX II 2G



C US

### EEXIA



### EV71 - DIMENSIONI / DIMENSIONS

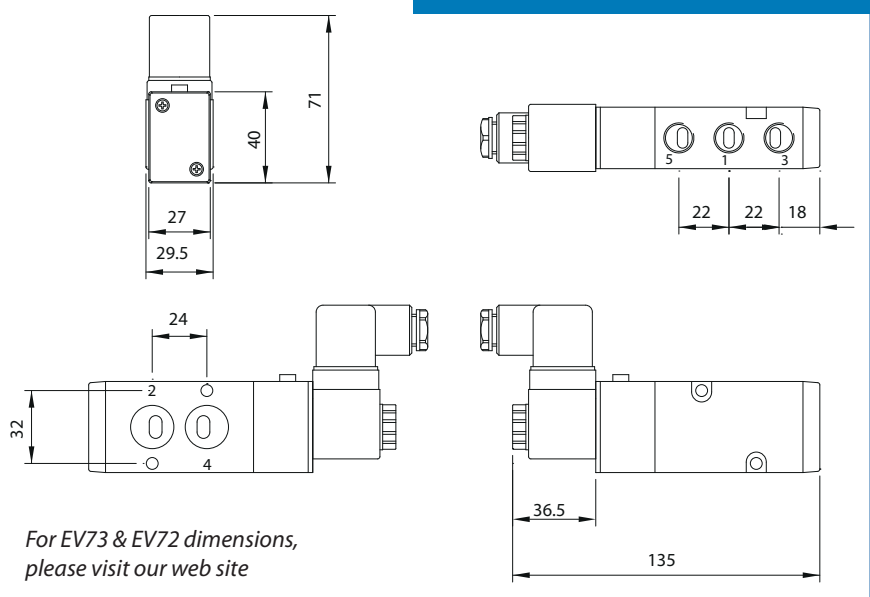

# SERIE NAMUR "81 - 82 - 83" - IP65 - EXPLOSION PROOF Exm IIC T5

La serie EV81, EV82 & EV83 sono elettrovalvole NAMUR IP65 compatte, leggere e di semplice utilizzo, che possono essere usate in applicazioni antideflagranti. Equipaggiata con bobina con cavo da 1.2 mt standard, è dotata di comando manuale di serie e può essere convertita da 5 a 3 vie sul campo grazie ad una piastrina di conversione fornita nel kit standard.

The EV81, EV82 and EV83 solenoid valves are a compact IP65 rated NAMUR mount solenoid valve that is lightweight and can be installed in explosion proof applications. Equipped with coil with 1.2 mt cable as standard, this solenoid offers a standard manual override and comes as a standard 4-Way with easy conversion to a 3-Way for spring return (single-acting) applications.

## DATI TECNICI - TECHNICAL DATA

Pressione di Lavoro	2-8 Bar (30-120PSI)	Working pressure
Grado di protezione	IP65	Protection Degree
Connessioni pneumatiche	1/4"G (1/4"N)	Pneumatic Connection
Area di Installazione	Anti deflagrante Ex m II T5/T4 Explosion Proof	Area Protection
Temperatura Ambiente	Std: -20°C +50°C (-4°F +122°F) Option: -50°C +50°C (-58°F +122°F)	Ambient Temperature
Bobina	Class F 100% Duty	Coil
Cavo	Std: 1.2 m Option: 3 m & 5 m	Cable
Cv	1.1	Cv

## VOLTAGGI DISPONIBILI - COIL ELECTRICAL RATING

Voltaggio / Voltage	Power	Max
24 VDC	3W	±10%
24/110/220 VAC	4-4.8VA	±10%

Per altre tensioni, prego contattare i ns uffici - For other voltages, please contact our office

## MATERIALI - MATERIALS

Articolo	Materiale	Item	Material
Corpo	Alluminio Anodizzato/AISI316	Body	Anodized aluminum/ Stainless steel AISI 316
Spola	Alluminio Anodizzato/AISI316	Spool	Anodized aluminum/ Stainless steel AISI 316
Pilota	Ottone/Acciaio Inossidabile	Armature	Brass/Stainless steel
Molla	Acciaio/Acciaio inossidabile	Spring	Steel/Stainless steel
O Ring	NBR	O Ring	BUNA-N

### LEFT PILOT EV81

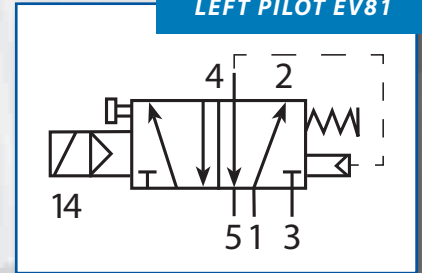

### RIGHT PILOT EV82

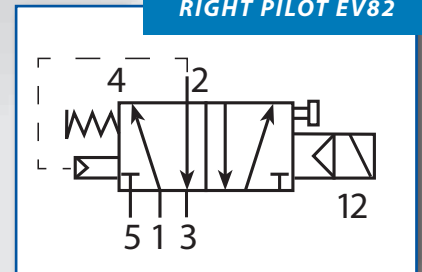

### DUAL COIL EV83

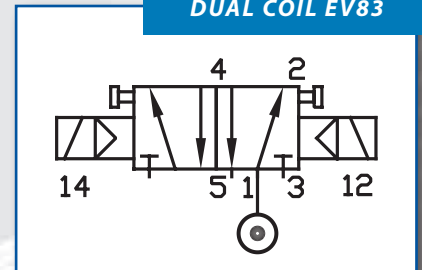

ATEX II 2GD

### EEXM



### EV81 - DIMENSIONI / DIMENSIONS

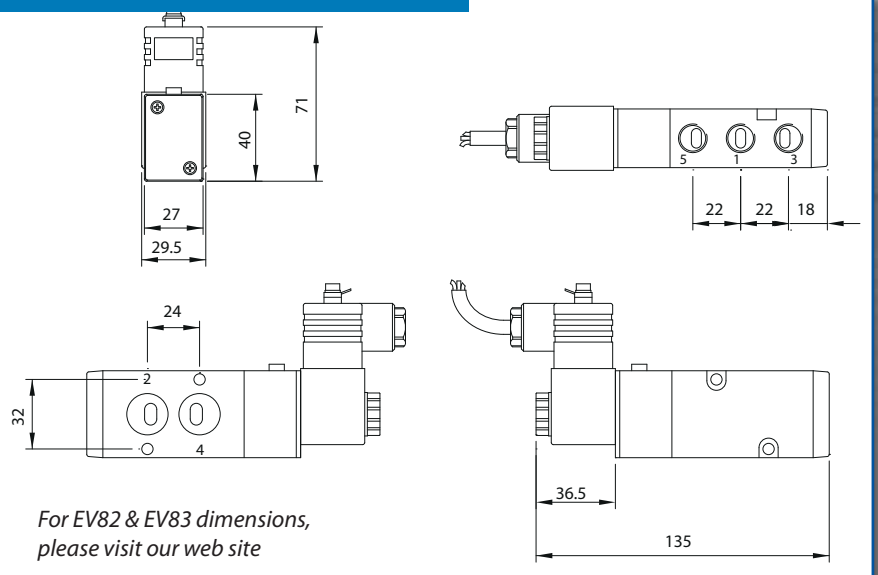

# SERIE NAMUR "91 - 92 - 93" – IP65 – EXPLOSION PROOF NEMA 7

La serie SV91, SV92 & SV93 sono elettrovalvole NAMUR IP65 compatte, leggere e di semplice utilizzo, che possono essere utilizzate in ambienti esplosivi. Equipaggiata con bobina in classe H come standard, è dotata di comando manuale di serie e può essere convertita da 5 a 3 vie sul campo grazie ad una piastrina di conversione fornita nel kit standard.

The SV91, SV92 and SV93 solenoid valves are a compact, light-weight solenoid that can be used in explosion proof applications. These solenoids come standard with Class H coils and both 3-Way and 5-Way field conversion kits.

## DATI TECNICI – TECHNICAL DATA

Pressione di Lavoro	2-8 Bar (30-120PSI)	Working pressure
Grado di protezione	IP65	Protection Degree
Connessioni pneumatiche	¼"N	Pneumatic Connection
Connessioni Elettriche	Flying leads, ½"NPT	Electrical connection
Temperatura Ambiente	-20°C +60°C (-4°F +140°F)	Ambient Temperature
Area di Installazione	Anti deflagrante NEMA 7 – Ex m II T4 Cl. I – Zone 1 Explosion proof	Area Protection
Bobina	Class H 100% Duty	Coil
Cv	1.1	Cv

## VOLTAGGI DISPONIBILI – COIL ELECTRICAL RATING

Voltaggio / Voltage	Hz	In Rush	Holding	Tolerance
24 VDC	--	4.5W		±10%
110 VAC	50	12.5VA	7.5VA	±10%
120 VAC	60	11.5VA	6.5VA	±10%

Per altre tensioni, prego contattare i ns uffici - For other voltages, please contact our office

## MATERIALI – MATERIALS

Articolo	Materiale	Item	Material
Corpo	Alluminio Anodizzato/AISI316	Body	Anodized aluminum/ Stainless steel AISI 316
Spola	Alluminio Anodizzato/AISI316	Spool	Anodized aluminum/ Stainless steel AISI 316
Pilota	Ottone/Acciaio Inossidabile	Armature	Brass/Stainless steel
Molla	Acciaio/Acciaio inossidabile	Spring	Steel/Stainless steel
O Ring	NBR	O Ring	BUNA-N

### LEFT PILOT SV91

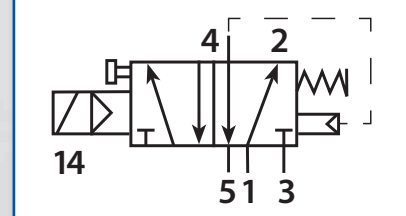

### RIGHT PILOT SV93

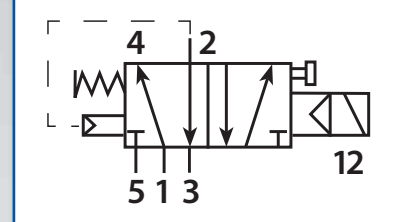

### DUAL COIL SV92

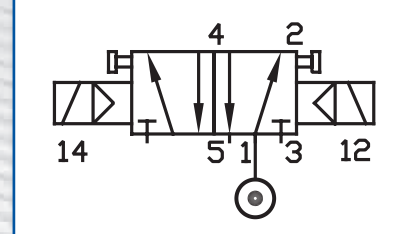

### NEMA 7



### SV91 - DIMENSIONI / DIMENSIONS

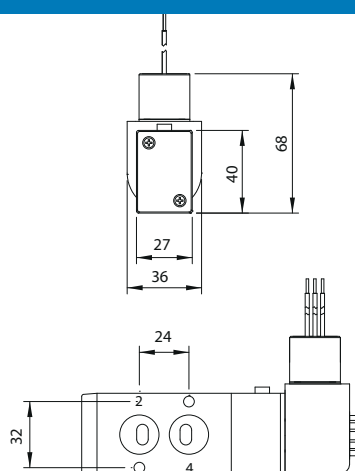

For SV92 & SV93 dimensions,  
please visit our web site

# SERIE NAMUR "51 - 52 - 53" - IP65 - EXPLOSION PROOF Ex dm IIC T4/T5

La serie EV51, EV52 & EV53 sono elettrovalvole NAMUR IP65 compatte, leggere e di semplice utilizzo, che possono essere utilizzate in ambienti esplosivi. Dotata di comando manuale di serie e può essere convertita da 5 a 3 vie sul campo grazie ad una piastrina di conversione fornita nel kit standard.

The EV51, EV52 and EV53 solenoid valves are a compact, light-weight solenoid that can be used in explosion proof applications. This light-weight, compact solenoid offers a standard manual override and comes as a standard 5-Way with easy conversion to a 3-Way for spring return (single-acting) applications.

## DATI TECNICI - TECHNICAL DATA

Pressione di Lavoro	2-8 Bar (30-120PSI)	Working pressure
Grado di protezione	IP65	Protection Degree
Connessioni pneumatiche	1/4"G (1/4"N)	Pneumatic Connection
Connessioni Elettriche	DIN 46320 PG9	Electrical connection
Temperatura Ambiente	Std: -20°C +50°C (-4°F +122°F) Option: -50°C +50°C (-58°F +122°F)"	Ambient Temperature
Area di Installazione	Anti deflagrante Ex dm IIC T4/T5 Explosion Proof	Area Protection
Bobina	Class F 100% Duty	Coil
Cv	1.1	Cv

## VOLTAGGI DISPONIBILI - COIL ELECTRICAL RATING

Voltaggio / Voltage	Power	Tolerance
24 VDC	3W	±10%
24/110/220 VAC	3.2VA	±10%

Per altre tensioni, prego contattare i ns uffici - For other voltages, please contact our office

## MATERIALI - MATERIALS

Articolo	Materiale	Item	Material
Corpo	Alluminio Anodizzato/AISI316	Body	Anodized aluminum/ Stainless steel AISI 316
Spola	Alluminio Anodizzato/AISI316	Spool	Anodized aluminum/ Stainless steel AISI 316
Pilota	Ottone/Acciaio Inossidabile	Armature	Brass/Stainless steel
Molla	Acciaio/Acciaio inossidabile	Spring	Steel/Stainless steel
O Ring	NBR	O Ring	BUNA-N

### LEFT PILOT EV51

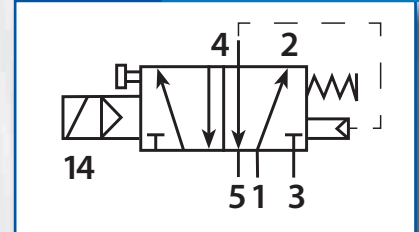

### RIGHT PILOT EV53

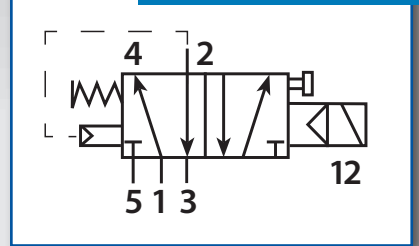

### DUAL COIL EV52

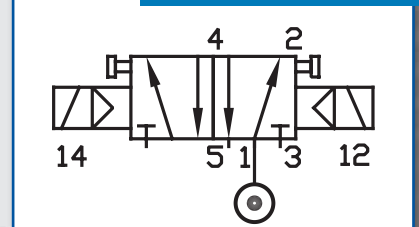

ATEX II 2GD

### EV51



### EV51 - DIMENSIONI / DIMENSIONS

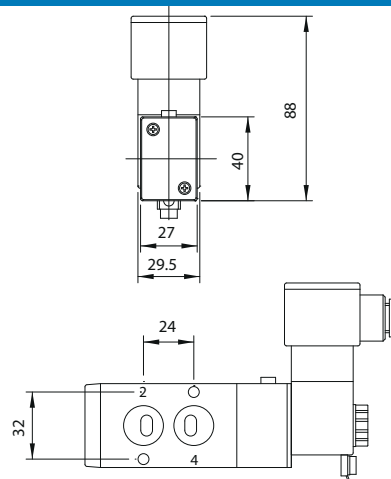

For EV52 & EV53 dimensions,  
please visit our web site

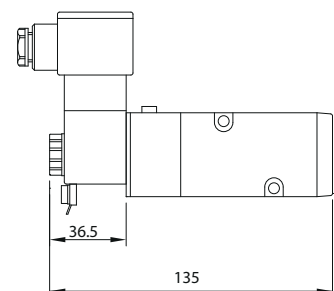
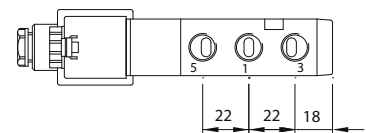

# SERIE INLINE "10" - IP65 - ORDINARY LOCATION

La serie EV10 sono elettrovalvole INLINE IP65 compatte, leggere e di semplice utilizzo. Dotate di comando manuale di serie, può essere fornita in versione 5 o 3 vie.

The EV10 solenoid valves are a compact IP65 rated INLINE mount solenoid valve that is lightweight and easy to use. This light-weight, compact solenoid offers a standard manual override and comes either in 5 way or 3 way version.

## DATI TECNICI - TECHNICAL DATA

Pressione di Lavoro	2-8 Bar (30-120PSI)	Working pressure
Grado di protezione	IP65	Protection Degree
Conessioni pneumatiche	¼"G (1/4"N) ½"G (1/2"N)	Pneumatic Connection
Conessioni Elettriche	DIN 43650B PG9 (½"N)	Electrical connection
Temperatura Ambiente	-20°C +60°C (-4°F +140°F)	Ambient Temperature
Area Installazione	Sicura - Safe Ex nA T4/T5 (optional)	Area Protection
Bobina	Class F 100% Duty	Coil
Cv	1.1 (¼") 2.5 (½")	Cv

## VOLTAGGI DISPONIBILI - COIL ELECTRICAL RATING

Vtaggio / Voltage	Power	Tolerance
12/24/48 VDC	3W	±10%
24/48/110/220 VAC	5VA	±10%

## MATERIALI - MATERIALS

Articolo	Materiale	Item	Material
Corpo	Alluminio Anodizzato/AISI316	Body	Anodized aluminum/ Stainless steel AISI 316
Spola	Alluminio Anodizzato/AISI316	Spool	Anodized aluminum/ Stainless steel AISI 316
Pilota	Ottone/Acciaio Inossidabile	Armature	Brass/Stainless steel
Molla	Acciaio/Acciaio inossidabile	Spring	Steel/Stainless steel
O Ring	NBR	O Ring	BUNA-N

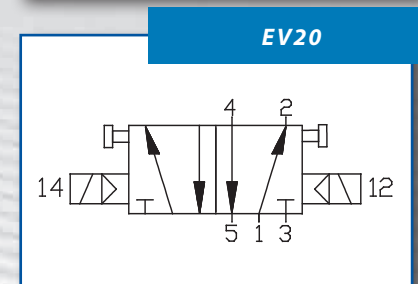
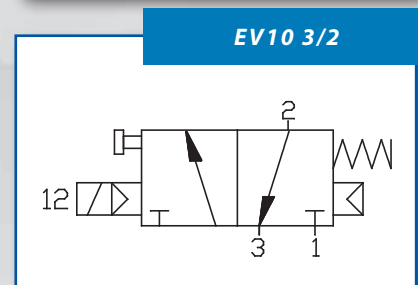
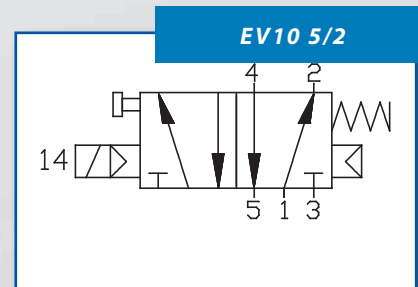

ATEX II 3GD

## DIMENSIONI / DIMENSIONS

EV10 5/2

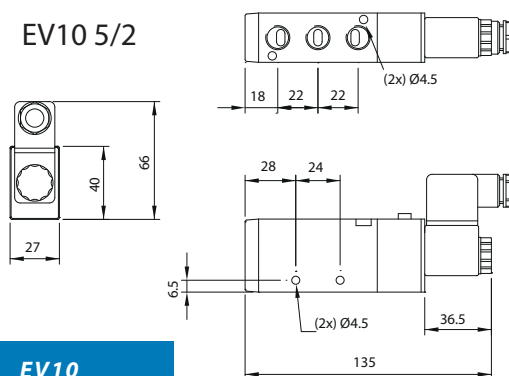

EV10 3/2

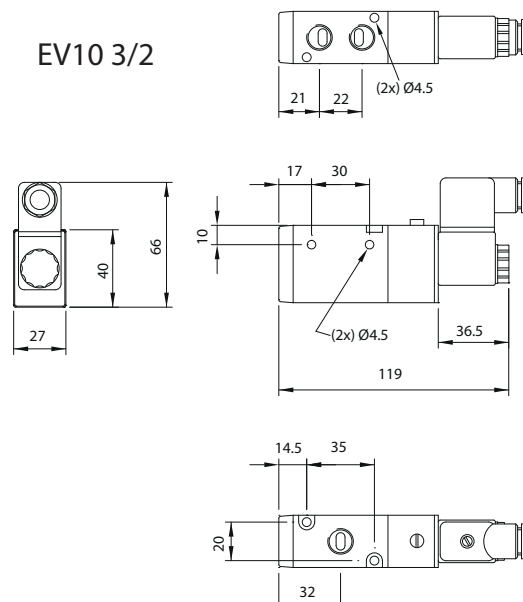

EV10





# SERIE INLINE "17" - IP65 - INTRINSICALLY SAFE Exia IIC T4/T6

La serie EV17 sono elettrovalvole INLINE IP65 compatte, leggere e di semplice utilizzo, che possono essere utilizzate in applicazioni a Sicurezza Intrinseca. È importante notare che una corretta barriera deve essere utilizzata congiuntamente all'elettrovalvola.

Dotate di comando manuale di serie, può essere fornita in versione 5 0 3 vie. Compatibile con barriere Pepperl & Fuchs KFD2-SL2-Ex2 and KFD2-SD-Ex 1.36.

The EV17 solenoid valves are a compact, light-weight solenoid that can be used in intrinsically safe applications. It is important to note that a proper safety barrier needs to be used in conjunction with the solenoid valve. Solenoids come either in 3-Way or 5-Way version.

Compatible barriers to use are Pepperl & Fuchs KFD2-SL2-Ex2 and KFD2-SD-Ex 1.36.

## DATI TECNICI - TECHNICAL DATA

Pressione di Lavoro	2-8 Bar (30-120PSI)	Working pressure
Grado di protezione	IP65	Protection Degree
Connessioni pneumatiche	1/4" G (1/4" N) 1/2" G (1/2" N)	Pneumatic Connection
Connessioni Elettriche	DIN 43650A PG9 (1/2" N)	Electrical connection
Temperatura Ambiente	-20°C +60°C (-4°F +140°F)	Ambient Temperature
Area di Installazione	A Sicurezza Intrinseca Ex ia IIC T6/T4 Intrinsically Safe	Area Protection
Bobina	Class F 100% Duty	Coil
Cv	1.1 (1/4") 2.5 (1/2")	Cv

## VOLTAGGI DISPONIBILI - COIL ELECTRICAL RATING

Voltaggio / Voltage	A	Max	I <sub>≤</sub>	P <sub>≤</sub>
24 VDC	0.05A	28VDC	115mA	1.6W

## MATERIALI - MATERIALS

Articolo	Materiale	Item	Material
Corpo	Alluminio Anodizzato/AISI316	Body	Anodized aluminum/ Stainless steel AISI 316
Spola	Alluminio Anodizzato/AISI316	Spool	Anodized aluminum/ Stainless steel AISI 316
Pilota	Ottone/Acciaio Inossidabile	Armature	Brass/Stainless steel
Molla	Acciaio/Acciaio inossidabile	Spring	Steel/Stainless steel
O Ring	NBR	O Ring	BUNA-N

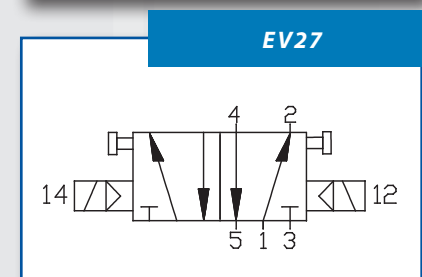
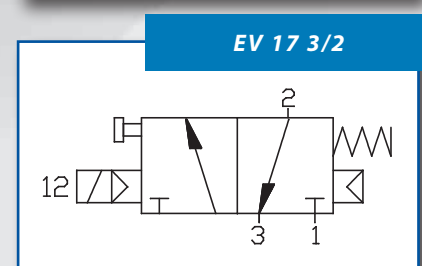
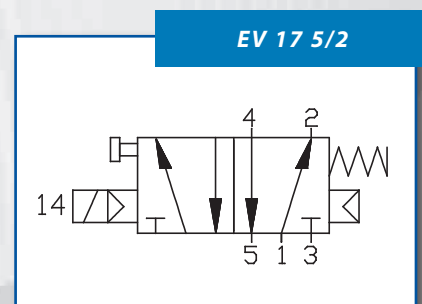

## DIMENSIONI / DIMENSIONS

EV17 5/2

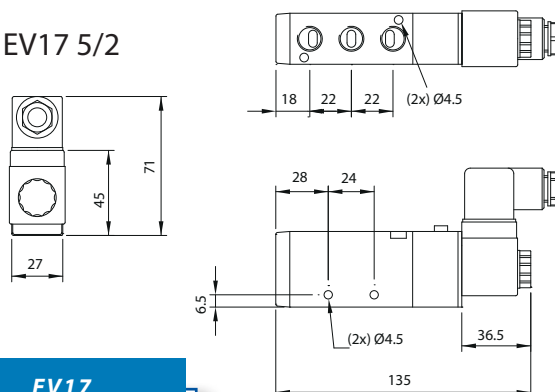

EV17 3/2

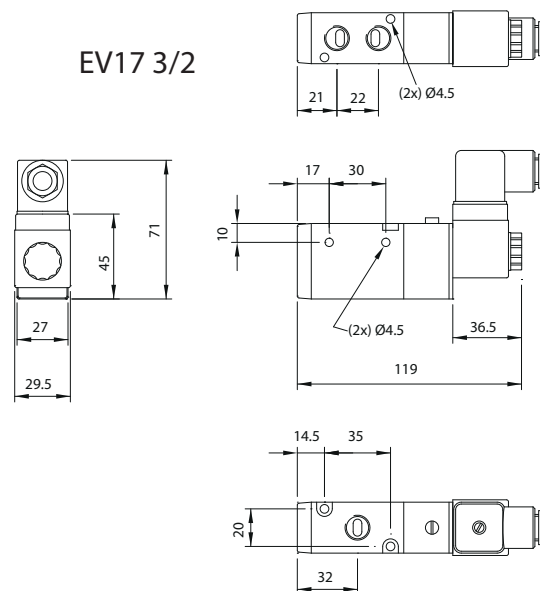

EV17

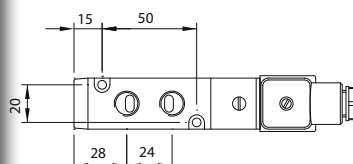

# SERIE INLINE "18" - IP65 - EXPLOSION PROOF Exm IIC T5

La serie EV18 sono elettrovalvole INLINE IP65 compatte, leggere e di semplice utilizzo, che possono essere usate in applicazioni antideflagranti. Equipaggiata con bobina con cavo da 1.2 mt standard, è dotata di comando manuale di serie e può essere fornita a 5 o 3 vie.

The EV18 solenoid valves are a compact IP65 rated INLINE mount solenoid valve that is lightweight and can be installed in explosion proof applications. Equipped with coil with 1.2 mt cable as standard, this solenoid offers a standard manual override and comes either in 5-Way or 3-Way version.

## DATI TECNICI - TECHNICAL DATA

Pressione di Lavoro	2-8 Bar (30-120PSI)	Working pressure
Grado di protezione	IP65	Protection Degree
Connessioni pneumatiche	¼"G (1/4"N) ½"G (1/2"N)	Pneumatic Connection
Area di Installazione	Anti deflagrante Ex m II T5/T4 Explosion Proof	Area Protection
Temperatura Ambiente	Std: -20°C +50°C (-4°F +122°F) Option: -50°C +50°C (-58°F +122°F)	Ambient Temperature
Bobina	Class F 100% Duty	Coil
Cavo	Std: 1.2 m Option: 3 m & 5 m	Cable
Cv	1.1 (¼") 2.5 (½")	Cv

## VOLTAGGI DISPONIBILI - COIL ELECTRICAL RATING

Voltaggio / Voltage	Power	Tolerance
24 VDC	3W	±10%
24/110/220 VAC	4-4.8VA	±10%

Per altre tensioni, prego contattare i ns uffici - For other voltages, please contact our office

## MATERIALI - MATERIALS

Articolo	Materiale	Item	Material
Corpo	Alluminio Anodizzato/AISI316	Body	Anodized aluminum/ Stainless steel AISI 316
Spola	Alluminio Anodizzato/AISI316	Spool	Anodized aluminum/ Stainless steel AISI 316
Pilota	Ottone/Acciaio Inossidabile	Armature	Brass/Stainless steel
Molla	Acciaio/Acciaio inossidabile	Spring	Steel/Stainless steel
O Ring	NBR	O Ring	BUNA-N

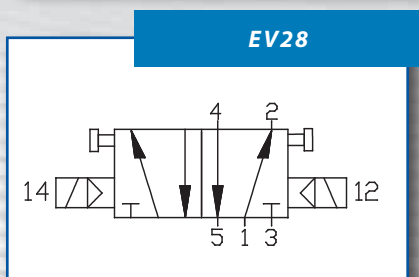
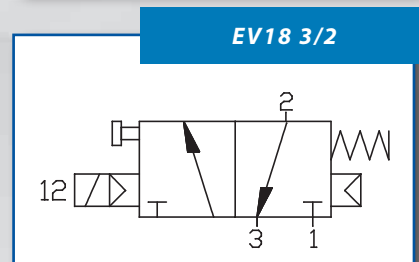
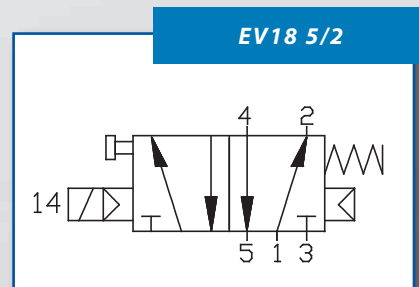

ATEX II 2GD

## DIMENSIONI / DIMENSIONS

EV18 5/2

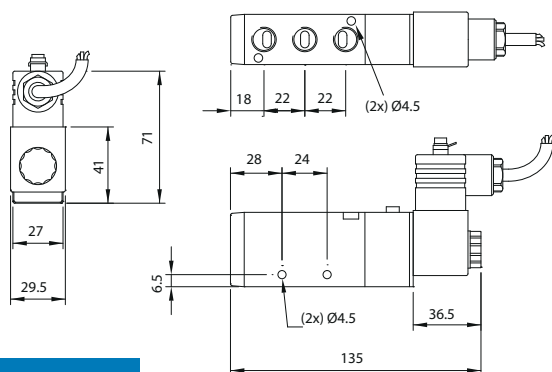

EV18 3/2

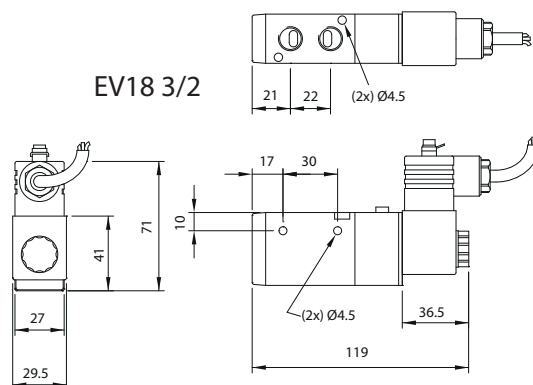

EV18

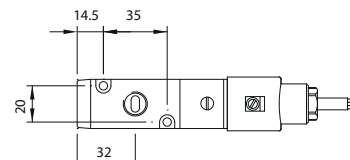
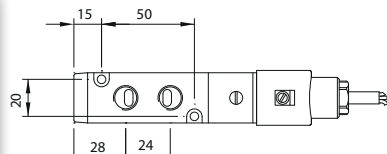

# SERIE INLINE "19" - IP65 - EXPLOSION PROOF NEMA 7

La serie SV19 sono elettrovalvole NAMUR IP65 compatte, leggere e di semplice utilizzo, che possono essere utilizzate in ambienti esplosivi. Equipaggiata con bobina in classe H come standard, è dotata di comando manuale di serie e può essere fornita in versione 5 o 3 vie.

The SV19 solenoid valves are a compact, light-weight solenoid that can be used in explosion proof applications. These solenoids come standard with Class H coils either in 3-Way or 5-Way version.

## DATI TECNICI - TECHNICAL DATA

Pressione di Lavoro	2-8 Bar (30-120PSI)	Working pressure
Grado di protezione	IP65	Protection Degree
Connessioni pneumatiche	1/4" N (1/2" N)	Pneumatic Connection
Connessioni Elettriche	Flying leads, 1/2" NPT	Electrical connection
Temperatura Ambiente	-20°C +60°C (-4°F +140°F)	Ambient Temperature
Area di Installazione	Anti deflagrante NEMA 7 - Ex m II T4 Cl. I - Zone 1 Explosion proof	Area Protection
Bobina	Class H 100% Duty	Coil
Cv	1.1 (1/4") 2.5 (1/2")	Cv

## VOLTAGGI DISPONIBILI - COIL ELECTRICAL RATING

Voltaggio / Voltage	Hz	In Rush	Holding	Tolerance
24 VDC	--	4.5W		±10%
110 VAC	50	12.5VA	7.5VA	±10%
120 VAC	60	11.5VA	6.5VA	±10%

Per altre tensioni, prego contattare i ns uffici - For other voltages, please contact our office

## MATERIALI - MATERIALS

Articolo	Materiale	Item	Material
Corpo	Alluminio Anodizzato/AISI316	Body	Anodized aluminum/ Stainless steel AISI 316
Spola	Alluminio Anodizzato/AISI316	Spool	Anodized aluminum/ Stainless steel AISI 316
Pilota	Ottone/Acciaio Inossidabile	Armature	Brass/Stainless steel
Molla	Acciaio/Acciaio inossidabile	Spring	Steel/Stainless steel
O Ring	NBR	O Ring	BUNA-N

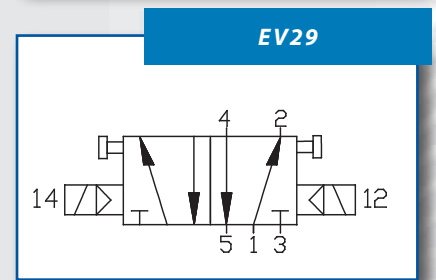
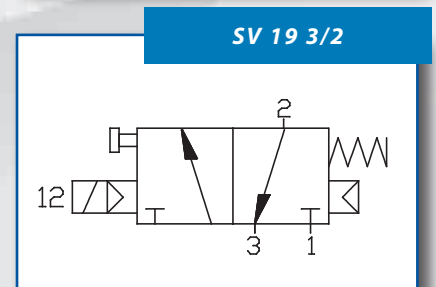
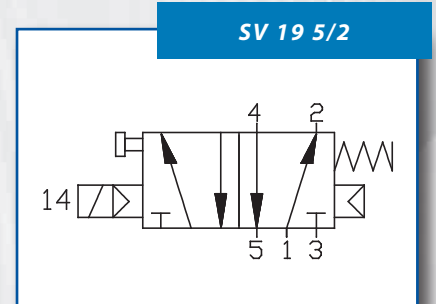

## DIMENSIONI / DIMENSIONS

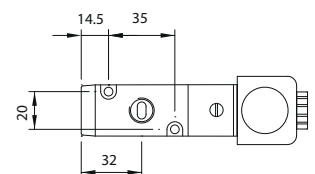
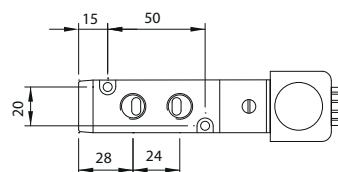
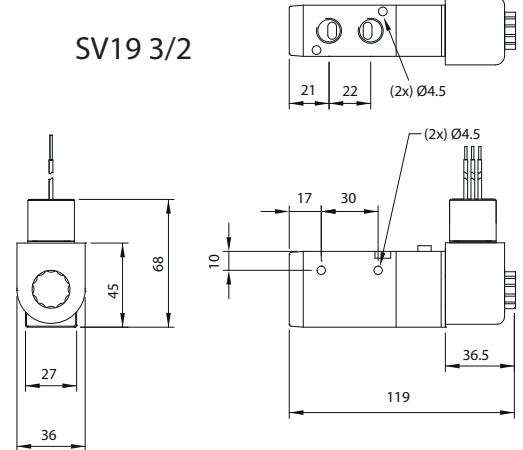
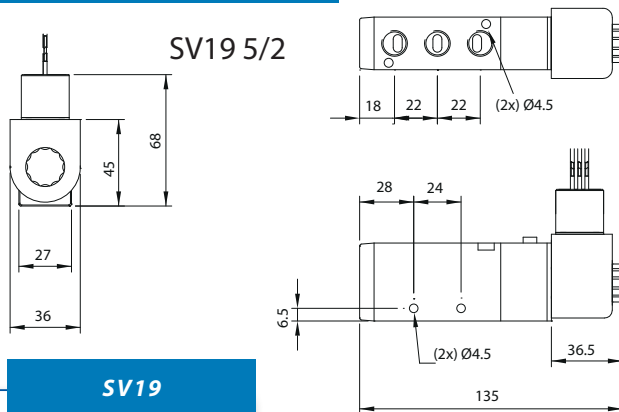

# SERIE INLINE "15" - IP65 - EXPLOSION PROOF Ex dm IIC T4/T5

La serie EV15 sono elettrovalvole NAMUR IP65 compatte, leggere e di semplice utilizzo, che possono essere utilizzate in ambienti esplosivi. Dotata di comando manuale di serie e può essere fornita a 5 o 3 vie.

The EV15 solenoid valves are a compact, light-weight solenoid that can be used in explosion proof applications. This light-weight, compact solenoid offers a standard manual override and comes either as 5-Way or 3-Way version.

## DATI TECNICI - TECHNICAL DATA

Pressione di Lavoro	2-8 Bar (30-120PSI)	Working pressure
Grado di protezione	IP65	Protection Degree
Connessioni pneumatiche	1/4"G (1/4"N) 1/2"G (1/2"N)	Pneumatic Connection
Connessioni Elettriche	DIN 46320 PG9	Electrical connection
Temperatura Ambiente	Std: -20°C +50°C (-4°F +122°F) Option: -50°C +50°C (-58°F +122°F)	Ambient Temperature
Area di Installazione	Anti deflagrante Ex dm IIC T4/T5 Explosion Proof	Area Protection
Bobina	Class F 100% Duty	Coil
Cv	1.1 (1/4") 2.5 (1/2")	Cv

## VOLTAGGI DISPONIBILI - COIL ELECTRICAL RATING

Voltaggio / Voltage	Power	Tolerance
24 VDC	3W	±10%
24/110/220 VAC	3.2VA	±10%

Per altre tensioni, prego contattare i ns uffici - For other voltages, please contact our office

## MATERIALI - MATERIALS

Articolo	Materiale	Item	Material
Corpo	Alluminio Anodizzato/AISI316	Body	Anodized aluminum/ Stainless steel AISI 316
Spola	Alluminio Anodizzato/AISI316	Spool	Anodized aluminum/ Stainless steel AISI 316
Pilota	Ottone/Acciaio Inossidabile	Armature	Brass/Stainless steel
Molla	Acciaio/Acciaio inossidabile	Spring	Steel/Stainless steel
O Ring	NBR	O Ring	BUNA-N

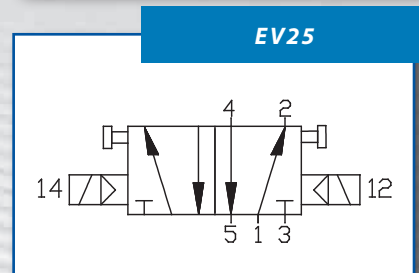
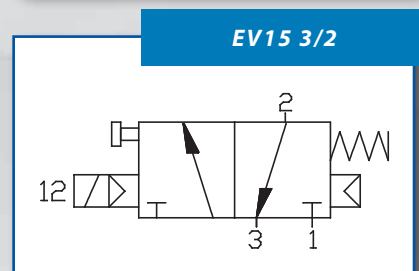
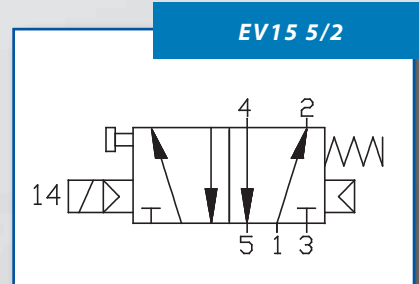

ATEX II 2GD

## DIMENSIONI / DIMENSIONS

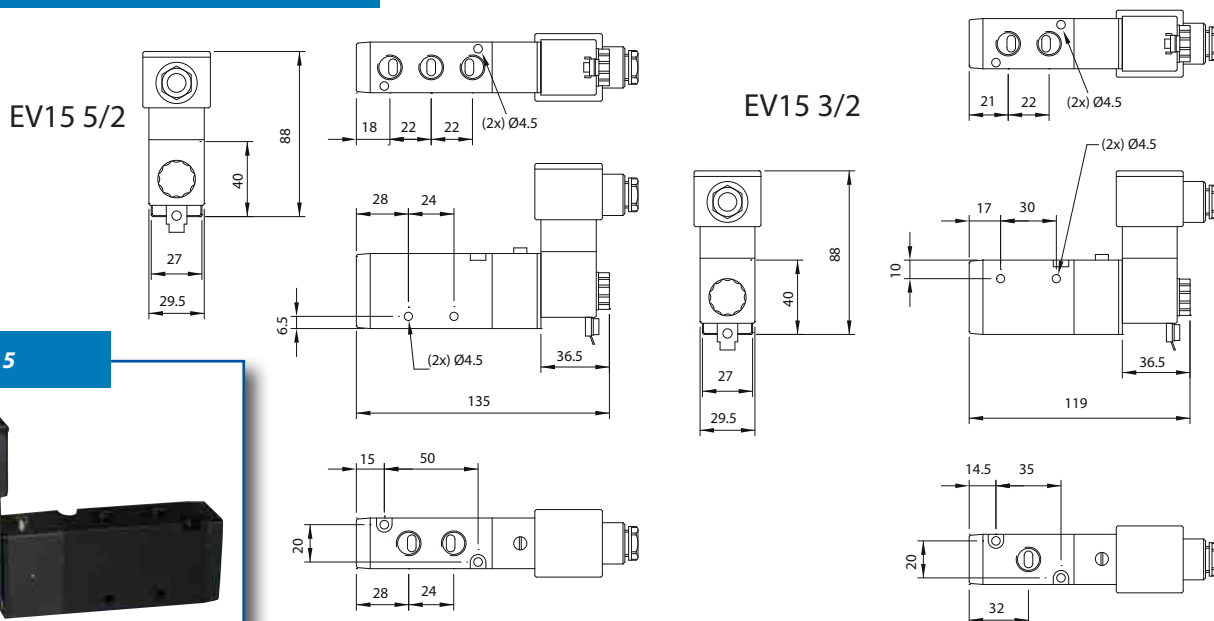

## EV15



CONNETTORI  
CONNECTORS



La Max-Air offre un kit connettore che consente di incrementare il rating IP da IP65 a IP67.

Il kit consiste di un connettore DIN con cavo stampato della lunghezza standard di 3 mt, in aggiunta a 3 O Ring.

*Max-Air Technology offers a seal kit that when used, increases the IP rating from IP65 to IP67.*

*This is useful where solenoid valves are exposed to excessive water conditions. The kit consists of a molded black DIN connector with a 3 mt lead and three o-rings.*

SC3 & SC5 REGOLATORI DI VELOCITÀ  
SC3 & SC5 SPEED REGULATOR PLATES



Le valvole della serie SC3 & SC5, realizzate in alluminio anodizzato, presentano interfaccia NAMUR e vengono interposte tra l'attuatore e l'elettrovalvola NAMUR. Grazie al design interno, consentono di regolare finemente la velocità di rotazione dell'attuatore sia in apertura che in chiusura. Max-Air consiglia l'utilizzo di questi componenti quando dei semplici regolatori installati sugli scarichi dell'elettrovalvola non siano sufficienti per ottenere un grado di regolazione soddisfacente sia per precisione che ripetibilità.

La versione SC3 viene impiegata in presenza di attuatori a semplice effetto. È disponibile in 2 versioni:

- SC3M00 regolazione attraverso viti incassate
- SC3M01 regolazione attraverso pomelli esterni

*SC3 & SC5 series, made in anodized aluminum, are NAMUR interface valves that mount in-line with other NAMUR components, such as a NAMUR solenoid valve, directly to the actuator inlet and exhaust ports allowing to finely adjusting the speed of the actuator rotation.*

*The SC3 series is used to adjust speed with spring return actuators and it is available in 2 versions:*

- *SC3M00 adjustment is performed thru screws*
- *SC3M01 adjustment is performed thru external handles*

La versione SC5 viene impiegata in presenza di attuatori a doppio effetto ed è disponibile in un'unica versione:

- SC5M00 regolazione attraverso viti incassate

*The SC5 series is used to adjust speed with double acting actuators and it is available only in 1 version:*

- *SC5M00 adjustment is performed thru screws*

SC3 - M01

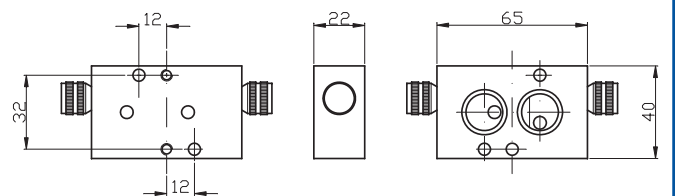

SC5

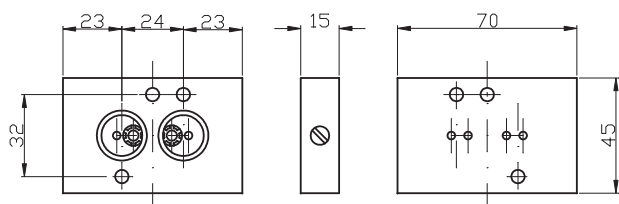

SC3

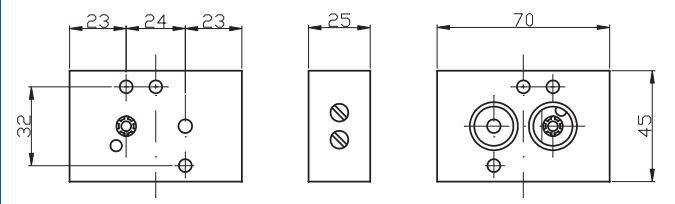

## SC6M01 REBREATHER



I blocchi Rebreather (SC6M01) della Max-Air con interfaccia NAMUR consentono di veicolare aria pulita da una camera all'altra dell'attuatore durante la fase di chiusura, evitando che l'aria corrosiva esterna all'attuatore venga aspirata nello stesso.

*NAMUR rebreather blocks recycle clean supply air from one chamber to the other during the closing stroke, preventing the actuator from "breathing" in corrosive environmental air.*

## SC8M01 - VALVOLA BLOCK &amp; BLEED

## SC8M01 - Block &amp; Vent valve

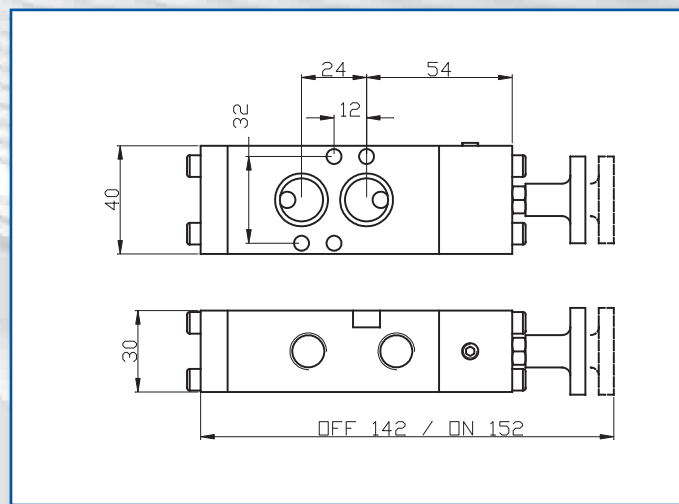

La valvola Block & Vent SC8M01, realizzata in alluminio anodizzato, è usualmente utilizzata in combinazione con un riduttore sganciabile. La valvola presenta interfaccia NAMUR e viene installata direttamente sull'attuatore, interposta tra lo stesso e una elettrovalvola NAMUR. Durante il normale funzionamento, la valvola SC8M01 è sganciata e consente all'aria di attraversarla, alimentando e scaricando le porte dell'attuatore. Quando viene agganciata, le porte dell'attuatore in alimentazione sono entrambe bloccate e al tempo stesso invece risultano aperte in scarico verso l'ambiente. In questo modo, l'utilizzatore può manualmente muovere la valvola senza bisogno di contrastare la forza dell'aria compressa. La Max-Air consiglia di utilizzare questa valvola per ogni gruppo che prevede l'utilizzo di un riduttore sganciabile.

*The SC8M01 Block & Bleed Valve, made in anodized aluminum, is most commonly used in combination with a declutchable gear override. This NAMUR accessory mounts in-line with other components such as NAMUR solenoid valve, directly to the actuator inlet and exhaust ports. During normal automated operation, the SC8M01 is disengaged and allows air to pass through. When the manual plunger is engaged, both actuator ports are blocked from incoming air and simultaneously allowed to exhaust (or "bleed") to atmosphere. In this mode, the user can now manually move the valve without fighting the air supply. Max-Air highly recommend the SC8M01 Block & Bleed Valve for any automated assembly using a declutch gear override.*

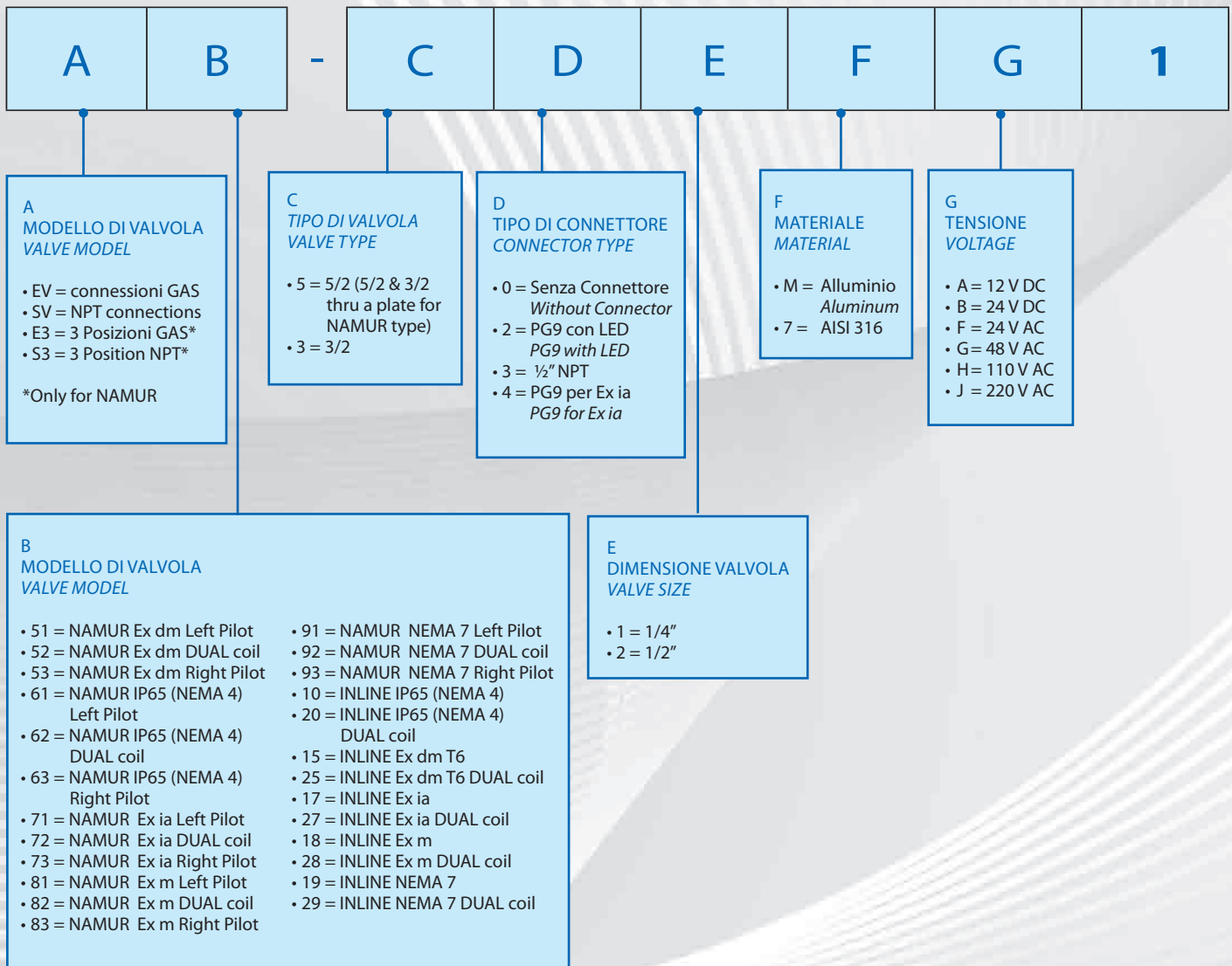

**NOTA:** Emme Technology nella continua ricerca volta a migliorare ed ampliare la gamma dei prodotti si riserva il diritto di cambiare o modificare le caratteristiche tecniche di progetto e di costruzione senza preavviso e senza incorrere nell'obbligo di apportare tali modifiche sui prodotti precedentemente o successivamente venduti.

**NOTE:** In continuing research to improve and expand the range of its product, Emme Technology reserves the right to change or modify product design or construction without prior notice and without incurring any obligation to make such changes or modifications on products previously or subsequently sold.



Rev. 01/2016

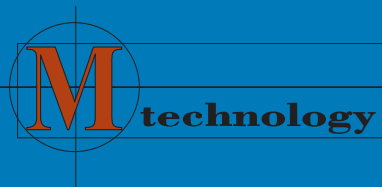

**Emme technology S.r.l.**

Via G. Di Vittorio 307/27 - 20099 Sesto San Giovanni (MI) - Italy  
Tel: +39.02.26262174 - Fax: +39.02.26220777 [www.emmetech.com](http://www.emmetech.com) E-mail: [sales@emmetech.com](mailto:sales@emmetech.com)